



Virtuoso Performance in Resident Care Beds

GlideAlign®
retractable deck technology

Smart Stop®
plus dual underbed lighting

Foot-end (staff) control
with lockout & advanced positioning

Floor lock / 360° mobility
Mobile or locked at any height

600 lbs / 272 kg SWL
(Safe Working Load)

ReadyWide® expander kit
(factory installed)

Built-in backup battery
(factory installed)

MODEL NUMBER	GlideAlign® retractable deck technology	Smart Stop® plus dual underbed lighting	Foot-end (staff) control with lockout & advanced positioning	Floor lock / 360° mobility Mobile or locked at any height	600 lbs / 272 kg SWL (Safe Working Load)	ReadyWide® expander kit (factory installed)	Built-in backup battery (factory installed)
MC9R	X	X	X	X	X		
MC9RW	X	X	X	X	X	X	
MC9RZ	X	X	X	X	X		X
MC9RWZ	X	X	X	X	X	X	X

Height Floor to Mattress Support	7-7/8" - 31" / 200 mm - 787 mm
Deck Angles - Back Elevation	0 - 70°
Deck Angles - Knee Elevation	0 - 30°
Bed Length - Overall Length	82", 86", 90" / 2083 mm, 2184 mm, 2286 mm
Bed Length - Retraction Travel	12" / 305 mm
Bed Length - Sleep Surface	76", 80", 84" / 1930 mm, 2032 mm, 2134 mm
Bed Width - With Side Rails	40-1/2", 43-1/2", 46-1/2" / 1029 mm, 1105 mm, 1181 mm
Bed Width - Sleep Surface	35", 39", 42" / 889 mm, 991 mm, 1067 mm
Mattress Support Deck Const.	Welded steel tube and slats
Mattress Stops	Steel Corner and Side Stops
Bed End Panels	Permanent or removable mounting
Electrical & Mechanical Certification	ANSI/AAMI ES60601-1:2005, Medical electrical equipment CAN/CSA-C22.2 NO. 60601-1-08 - Medical electrical equipment CAN/CSA-C22.2 NO. 60601-2-52:11 - Medical Beds CAN/CSA-C22.2 NO. 60601-1-2-08 - EMC
Classification	Class 1, Type B
VAC/Hertz/Phase	120/60/1
Maximum Input Current Rating	3.5 Amp (120V)

Cord Type/Length	2.5 Meters minimum, 3 prong hospital grade plug
Electric Motors	Four (4) DC self-lubricating linear actuators
Operation	10% Maximum Duty Cycle (2 minutes on, 18 minutes off)
Emergency Power back-up battery Pack	24V DC Internal or External Battery with Charger
Ingress Protection Rating	IPX4 (Electrical components IP66)
Audible Acoustic Energy	Less than 80 dBA
Weight of Bed	253 lbs / 115 kg without any accessories
Safe Working Load	600 lbs / 272 kg (Includes weight of accessories, options and bedding)
Mobility	At any height (7-7/8" - 31" / 200 mm - 787 mm)
Swivel Casters	Heavy duty dual 3" (76 mm) Casters
Warranty	Mechanical: 5 years; Frame: 10 years; Welds: 15 years.

Outfit your Encore with one of Span's many outstanding support surfaces up to 42" (1067 mm) wide. Options include:

PressureGuard® Easy Air™ Series



Geo-Mattress® Atlas™ Bariatric Foam

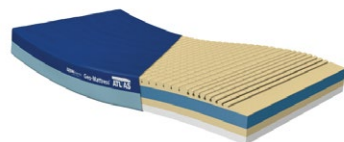

Geo-Mattress® UltraMax™ Therapeutic Foam

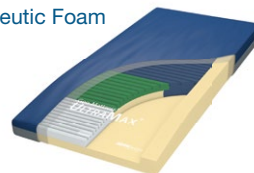

Custom Care® Convertible Series

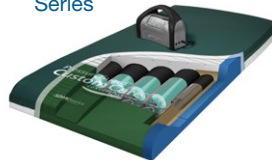

SPAN
better science. better care.

Span Medical Products Canada, Inc.
A subsidiary of Span-America Medical Products, Inc.

Beds/furniture
customer service:
800-268-8671

Support surfaces
customer service:
800-888-6752

spanamerica.com
© 2017 Span-America Medical Systems, Inc.

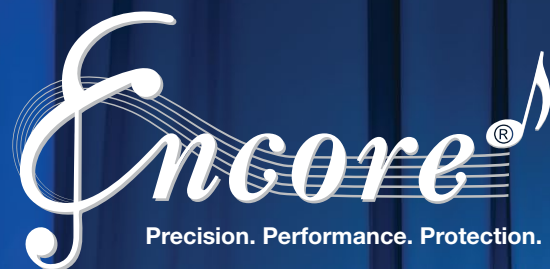

Precision. Performance. Protection.

Virtuoso Performance in Resident Care Beds



SPAN
better science. better care.

Online Resources



www.spanamerica.com/encorevideo

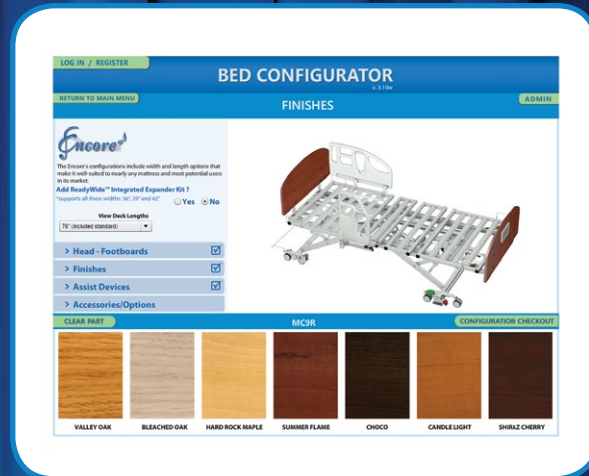

We invite you to use the link at left to view a video performance of all of Encore's key features and operate the bed yourself in virtual 3D.

And, visit our website to try out the **Bed Configurator**, which allows you to outfit and view an Encore bed with the options that meet the specific demands of your caregiving environment.

Innovative features, operating in concert.

Encore®

Provides enhanced levels of care and comfort for the user, better ergonomics and protection from injury for the caregiver.

KEY ENCORE INNOVATIONS:

- Glide Align® retractable deck technology
- ReadyWide® integrated expandability
- SmartStop® low position auto-pause

page 4
page 6
page 7



GlideAlign® Retractable Deck Technology

Perfectly aligned with your facility's safety goals.

Superior fall prevention: By helping the user maintain vertical alignment, Encore helps ensure that all points in the bed environment remain more safely within user's reach (see illustrations p. 5).

Superior staff protection: Helps offset the tendency to slide down in bed as head of bed (HOB) is elevated, reducing the need for frequent repositioning that can lead to staff patient handling injuries.

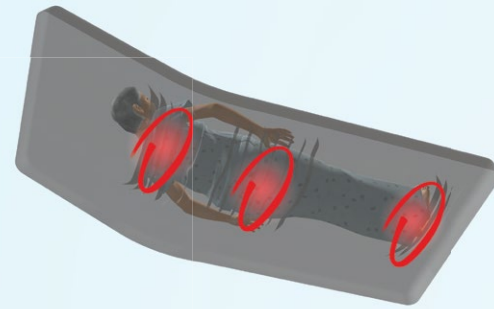

Superior protection from shearing

By reducing sliding during HOB elevation, helps minimize opportunity for skin shearing at vulnerable sacrum, scapula and heels.

Encore's deck moves — so the user doesn't have to.

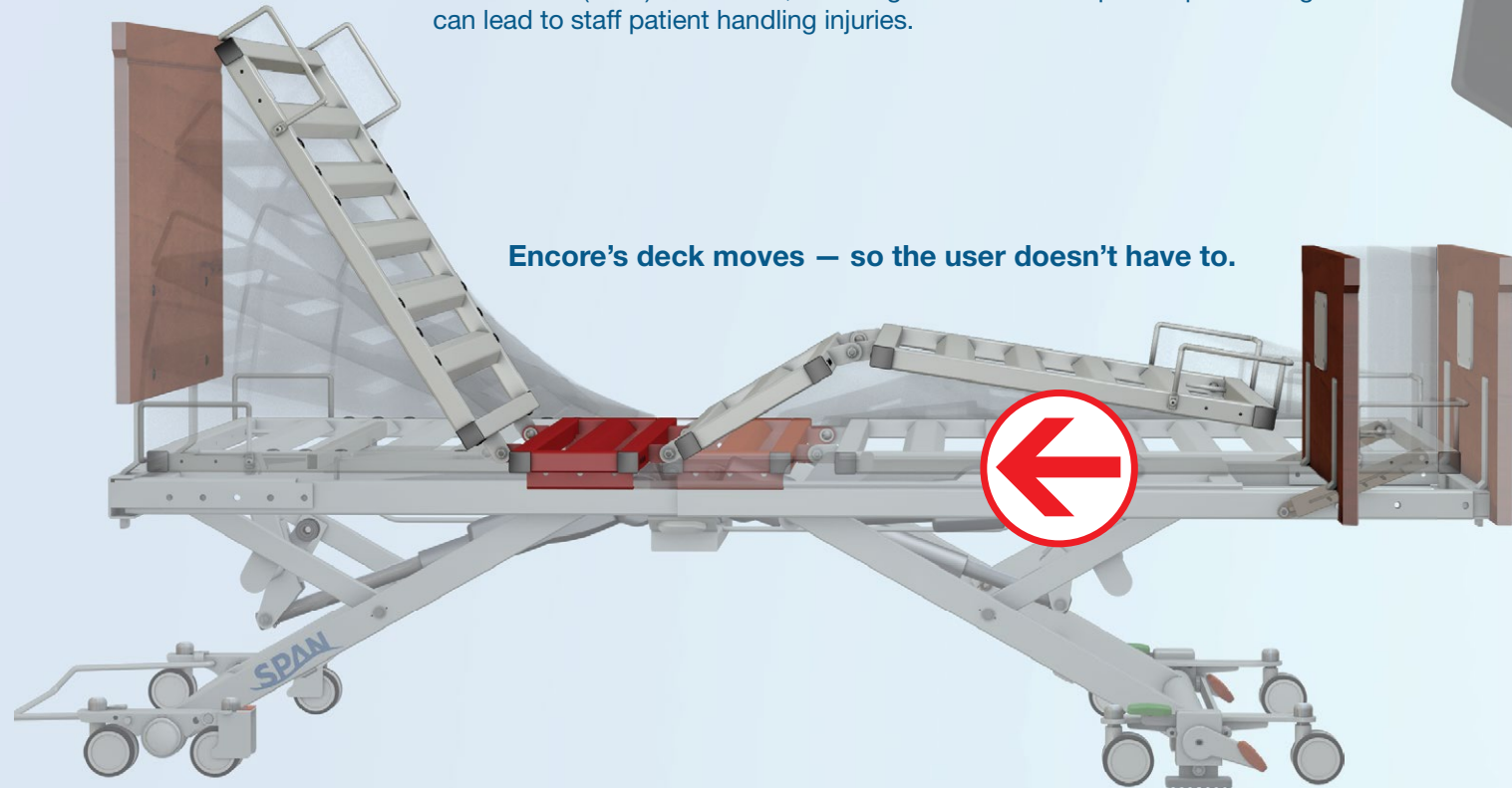

ALIGNMENT ZONE



ALIGNMENT ZONE



GlideAlign® is designed to help users access their environment comfortably, thereby reducing risk of falling or imbalance-related injury.

Movement of seat deck during HOB elevation

On typical beds, the seat deck does not move during HOB elevation, leaving users struggling uncomfortably and at risk of losing their balance.

Stationary seat deck

ReadyWide® Integrated Expansion

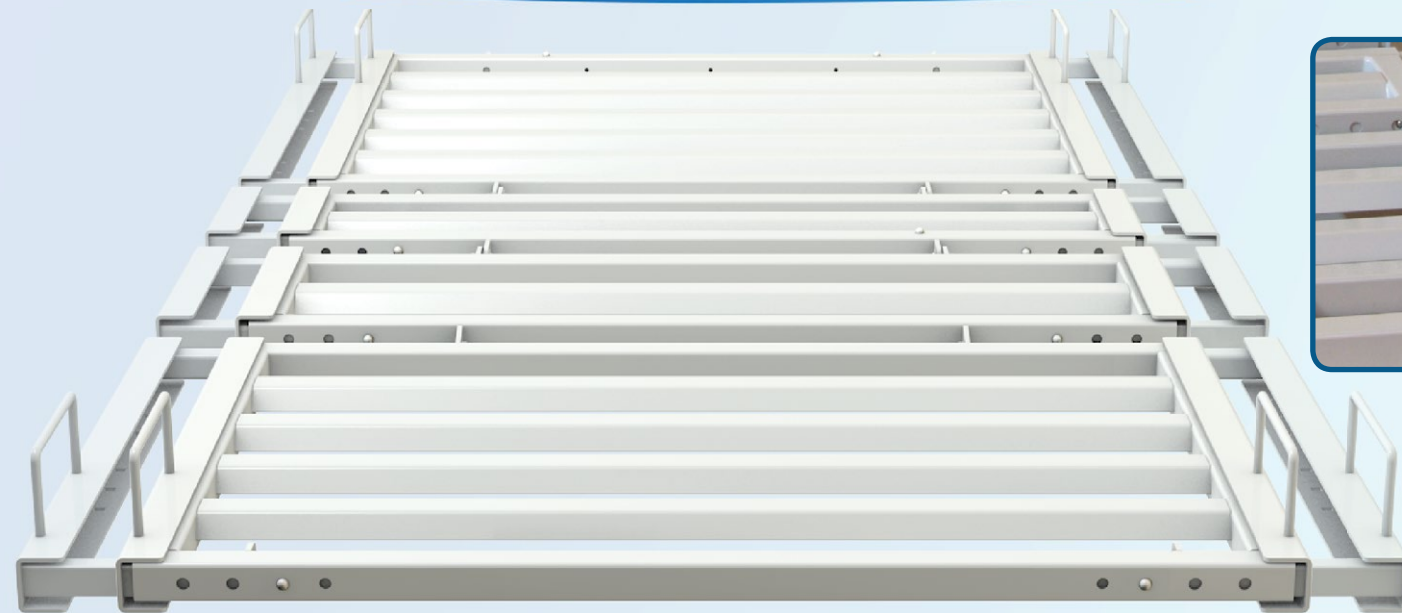

No bolts. No tools. No pins.
Retracts into deck. Nothing to store, lose, or become loose.



Tool-less, “two-click” expansion.



Navigates narrow doorways:
Fast, hassle-free bed mobility.

- **Simple, push-button operation:** Click once to pull expanders out to 39" (991 mm) wide. Click again for 42" (1067 mm) width.
- **Can be factory-installed at time of order,** or ordered separately as needed (see back page for options).
- **Expands treatment flexibility,** supported by Encore's 600 lb (272 kg) Safe Working Load (SWL).



Wider surface facilitates enhanced user comfort, fall prevention, transfers and ADLs.



Smart Stop® low position auto-pause

Smart Stop®
12.5" (318 mm)

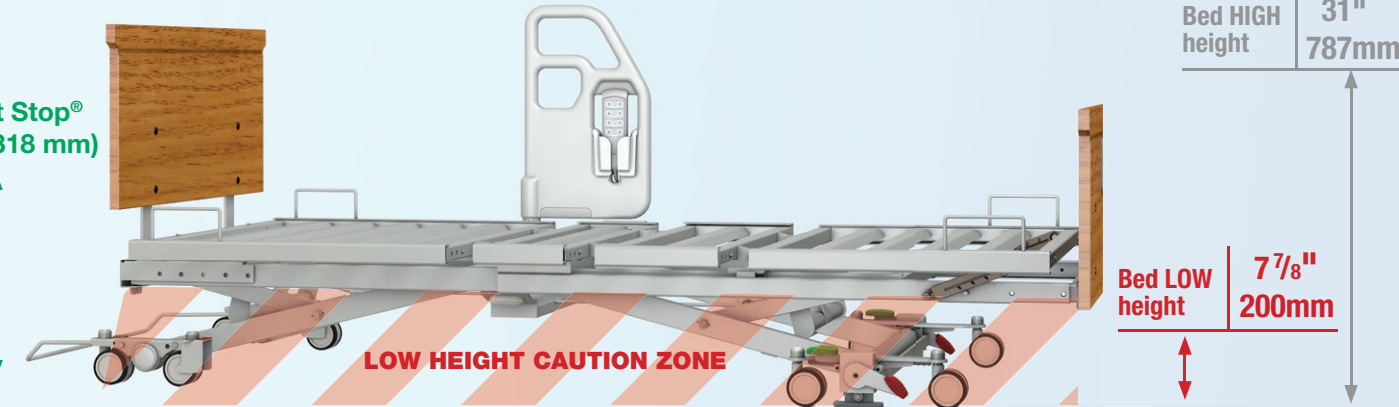

Dual underbed indicators flash as bed enters “low height caution zone.”

Improves low-bed safety and ergonomics:

- **Automatically stops lowering** when deck reaches 12.5" (318 mm) from floor.
- **Lowering can then be resumed** via foot-end (staff) control only.
- **Provides cue for caregiver** to confirm underbed clearance.
- **Eliminates potential hazard** of patient lowering bed onto unseen obstructions via hand pendant.
- **Can aid in reducing injury, falls** by users who might otherwise attempt egress from a “too-low” position.

90° angle

Helps ensure safer, more ergonomically correct transfers.
Positions typical user at ideal height* and leg angle for egress/regress.
(*12.5" (318 mm), plus height of mattress)



Key Standard Features

Head/footboard options see page 10



Trapezoidal slat profile provides unmatched strength, ventilation, and ease of cleaning.



Precision welds with lifetime guarantee.

Baseboard bumper

Hospital-grade ball bearing swivel casters, provide full mobility at any height. Head-end includes directional lock-out.

Mattress Retainers

Durable flexible polyester finish on individually powder-coated parts.

Four (4) synchronized DC self-lubricating actuators



Dual-position, dual-intensity underbed lighting.

- Standard on both left and right.
- Selectable bright or discreet nighttime floor level illumination.

Travels virtually straight up and down; maintains ample underbed clearance.



Backlit 9-button pendant with side-to-side adaptability.

Vascular foot ratchet elevates feet.

Standard model can be used at 76" or 80" (1930 mm or 2032 mm).

Advanced Clinical Positioning

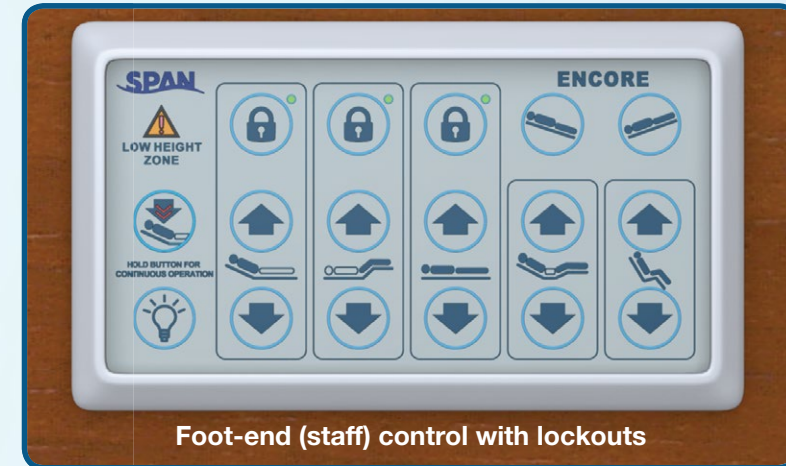

Foot-end (staff) control with lockouts



Auto Contour



Comfort Chair

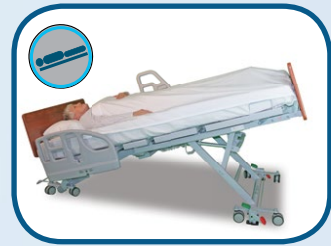

Trendelenburg

Reverse Trendelenburg



Smart Stop® low height warning/override



Foot-end floor lock can be custom-ordered for head end.

Options & Accessories

Finishes



Standard Profiles

Essex
Lincoln
Kent
Standard



Elite Profiles

Lethbridge
Pembroke
Trenton
Princeton



Encore

Recessed pendant holder, included, fits all rails and supports pendant facing either toward user or toward caregiver.



Bed extenders to 84" (2134 mm)

Q6690

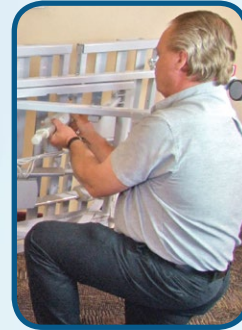

Transport Dollies for easy mobility and passage through narrow doorways; simplified access to under-bed components.

Q6699 (1 set)

10

Molded plastic quick release half-rail

R9308H (set of 2)

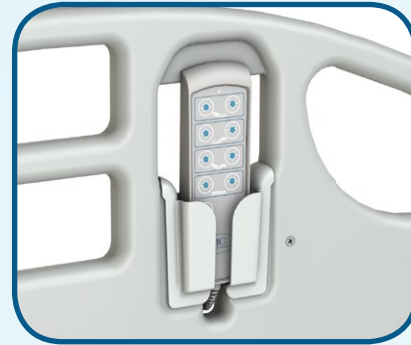

ReadyWide® integrated expanders

Q6689 (see page 6.)

Gooseneck headboard-mounted pendant holder

Q6417LP

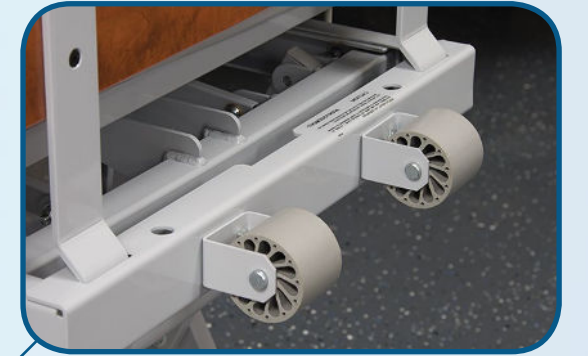

Honeycomb roller bumper kit

Q6708



Ergonomic 3-position assist device locks perpendicularly for sturdy ingress/egress support, protecting both user and caregiver. Both 3-position and half-length assist devices are made of molded, pleasing-to-touch plastic.

R9938 (1 ea, interchangeable L or R)
R9939 (set of 2)

Additional Accessories

- Built-in backup battery (factory- or field-installed)
- Portable backup battery
- Drainage hooks
- IV pole
- Trapeze



Bed & deck angle indicator kit

Q6703

11