

# Operating manual Original operating manual



## **CARLO Alu Classic 185 & Comfort EP 185**

Sling lift

Version 2.10 / E

Subject to technical modifications

2019-08-20

## Table of contents

1	Imprint .....	4
1.1	Acknowledgement .....	4
1.2	Manufacturer's address .....	4
1.3	TÜV quality seal .....	4
2	Introduction.....	5
2.1	Preface .....	5
2.2	Liability and warranty .....	5
3	The operating manual.....	6
3.1	Validity .....	6
3.2	Type plate.....	6
3.3	Designation.....	6
3.4	Variants .....	7
3.4.1	CARLO Alu Variants .....	7
3.4.2	Spreader Bar Variants.....	7
4	Safety .....	8
4.1	Intended and appropriate use.....	8
4.2	Other prescriptions .....	8
4.3	Safety instructions .....	8
4.4	List of used safety instructions.....	9
4.5	Warnings .....	10
5	Transport.....	12
5.1	Unpacking the product.....	12
5.1.1	Removing the cardboard.....	12
5.1.2	Loosening the product from the pallet.....	12
6	Installation .....	13
6.1	Electrical connection.....	13
6.2	First start-up .....	13
7	Operating elements and their function.....	14
7.1	Classic Spreader Bar Version.....	15
7.2	Handset .....	15
7.3	Explanation of the LED-indications on the Handset.....	16
7.4	Connections and Functions of the Control Unit .....	16
7.4.1	7.3.1 European Control Unit.....	16
7.4.2	Canadian Control Unit.....	17
7.5	24V-Battery Unit .....	17
7.6	External Charging Unit/Wall Charging Unit.....	18
7.7	Manual Emergency Lowering System .....	19
7.8	Electrical emergency lowering.....	19
7.9	Emergency stop switch.....	20
7.10	Motor Safety Measures .....	21

7.11	Impact and Jamming Protection (hoist motor).....	21
8	Operation.....	21
8.1	Sling Operating Manual .....	21
8.1.1	Prior to Use .....	21
8.1.2	During Use .....	22
8.1.3	After Use .....	26
8.2	Operation of the CARLO Alu .....	26
8.2.1	Explanation of the Functions of the Handset.....	26
8.2.2	Lifting a patient/resident .....	28
8.2.3	Putting the patient/resident down .....	29
8.3	Digital scale SLS (option) .....	29
8.4	Maintenance and Care of the 24-Volt Battery.....	30
9	Cleaning/Disinfection .....	30
9.1	Cleaning the lift.....	30
9.2	Disinfecting the lift .....	31
9.3	Sterilising the lift .....	31
10	Checks/tests .....	31
10.1	Prior to each use .....	32
11	Waste disposal .....	32
11.1	Disposal of the packaging material.....	32
11.2	Disposal of the product.....	32
12	Troubleshooting/After-sales service.....	33
12.1	Troubleshooting help.....	33
13	Appendix.....	35
13.1	Technical data .....	35
13.2	Dimensions CARLO Alu Classic 185 / EP 185.....	37
13.3	Declaration of Conformity .....	38
13.4	Accessories of the Sling Hoists CARLO Alu Classic 185Kg.....	39
13.5	Accessories CARLO Alu Comfort EP 185 .....	40
13.6	Spare parts / Consumables .....	43
13.7	Mounting instructions .....	44
13.7.1	Rear Castor Replacement .....	44
13.7.2	Front Castor Replacement.....	45
13.7.3	Control including Handle, Mounting Plate and Battery Compartment ...	46
13.7.4	Replacing the Battery .....	48
13.8	Electromagnetic Compatibility .....	49
13.9	Journal .....	53

# 1 Imprint

## 1.1 Acknowledgement

Dear customer, we would like to express our sincere thanks for the trust you have placed in us by purchasing this BEKA Hospitec GmbH product. Our products are manufactured and tested according to stringent quality criteria.

## 1.2 Manufacturer's address

	<p>BEKA Hospitec GmbH          Am Rübenmorgen 3          35582 Wetzlar          Phone: +49(0)641-9 22 22-0          Fax: +49(0)641-9 22-22-20  <a href="mailto:info@beka-hospitec.de">info@beka-hospitec.de</a></p>
---	---

## 1.3 TÜV quality seal

	<p>BEKA Hospitec GmbH is certified according to DIN EN ISO 13485 by TÜV SÜD Product Service GmbH. Therefore, the development, manufacturing, quality assurance and service of our entire product range is subject to high quality standards.</p>
---	--

## 2 Introduction

### 2.1 Preface

A correct use of the device is imperatively in order to ensure its proper and safe functioning. Please read the provided operating manual carefully and observe in particular the therein contained safety instructions.

The maintenance, inspection, assembly and installation as well as well as further technical interventions on the product must only be executed by BEKA Hospitec either by specialised companies authorised to this effect by BEKA Hospitec. The operation of the product as well as technical interventions on the product must only be carried out by specially trained personnel.

### 2.2 Liability and warranty

- On the basis of the information contained in this manual, the publisher accepts no liability for damages resulting from improper, incorrect or inappropriate use of the product. The product must only be operated by persons, who are familiar with the manual and the product as well as the national regulations, laws and prescriptions related to work, safety and accident prevention.
- The manufacturer of the product is only responsible for the safety and the reliability of the product, if regular functional tests and checks are conducted. Operate the product only with original accessories, otherwise the manufacturer's liability will expire.
- In case of technical interventions, such as extensions and fittings to our products, which are not carried out by BEKA Hospitec either by a specialist company authorised by BEKA Hospitec, all warranty rights on the modifications as well as on the device or on the device function, which are related to the modification, shall expire.
- For damages resulting from the use of spare parts and accessories, which are not authorized by the manufacturer, any further liability of the manufacturer shall be excluded.
- Please note that there might be minor differences between the images and explanations contained in this manual and the actually supplied device. Subject to technical modifications and error.
- The product is equipped with "B"-Type applied parts. All exposed, touchable, conductive parts are thereby considered as applied part.





### 3 The operating manual

#### 3.1 Validity

This operating manual contains information, which is required for the operation and use of the product. In addition to the description of the equipment, the operating manual also includes a number of abstractions and exemplary illustrations. The equipment of the product therefore may differ in part from the descriptions and illustrations. Furthermore, please observe also the manuals with regard to the cleaning and the disinfection as well as the assembly and the disassembly of individual components of the product.

Please read the operating manual and the safety instructions before starting to use the product. Keep the operating manual near the device for future reference.

#### 3.2 Type plate

  <p>BEKA Hospitec GmbH Am Rübenmorgen 3 D- 35582 Wetzlar Tel: +49 (0) 641 / 92 22 0 - 0 Fax: +49 (0) 641 / 92 22 0 - 20 www.beka-hospitec.de</p> 		<p>This image shows the type plate. The type plate is situated on the side of the operating panel. The serial number (SN) shown here, 0616123901, is merely an example. In case of queries, please mention the serial number printed on the type plate of your device.</p> <p><i>Note: Because of legal regulations, it might be required that the article number and the serial number should be computer-readable as well and therefore they might be printed on the type plate in the form of a bar code as well.</i></p>
Type: <b>CARLO Alu</b>  2016-05		
<b>SN</b> 0616123901 		
<b>REF</b> 924002018		
Operating Voltage: <b>24 V DC</b>	Max Patient weight: <b>185 kg / 408 lbs</b>	
Power Consumption Lifter: <b>Max. 240VA</b>	for charging use only BEKA- charger <b>Art.-No.: 921070702</b>	
Int. : 10%, Max. 2 min. / 18 min.		

#### 3.3 Designation

The different types described in this instruction manual (4 point spreader bar, Classic 6 point spreader bar, Classic and Comfort EP) are variations of “CARLO Alu”.

Any differences in use are given through extra references.

### 3.4 Variants

#### 3.4.1 CARLO Alu Variants

Article number	Description	Spreader bar
924003100	CARLO Alu, Classic 185	4-point spreader bar
924002008	CARLO Alu Classic 185	4-point spreader bar
924002018	CARLO Alu Classic 185	4-point spreader bar
924003200	CARLO Alu Classic 185	6-point spreader bar
924003208	CARLO Alu Classic 185 IL	6-point spreader bar
924003218	CARLO Alu Classic 185	6-point spreader bar
925006000	CARLO Alu Comfort EP 185	4-point EP spreader bar
925006008	CARLO Alu Comfort EP 185 IL	4-point EP spreader bar
925006018	CARLO Alu Comfort EP 185	4-point EP spreader bar

#### 3.4.2 Spreader Bar Variants



Classic version 4-point spreader bar



EP version, 4-point spreader bar



Classic version 6-point spreader bar with optional scale

## 4 Safety

### 4.1 Intended and appropriate use

The product has been designed for transferring residents in hospitals, nursing homes, care centers and facilities for the disabled. The resident can be lifted from a lying or sitting position or even from the ground. The product is to be used exclusively for the indoor transport of residents on smooth and level floorings.

The product is designed for a short-term use and any contact with injured skin must be avoided.

#### **Note**

No side effects associated to a treatment are known. However, you must still respect and observe the safety instructions and the contraindications.

#### **WARNING:**



Residents suffering from:

- Osteoporosis
- Spine disorders/spinal damage
- Osteogenesis imperfecta
- Mental confusion
- epileptic attacks

may only be treated with the CARLO Alu in consultation with the attending physician.

### 4.2 Other prescriptions

The product meets the current VDE-prescriptions 0100 and 0100-710. However, have a specialist company check the compliance of your electrical installation with the applicable prescriptions prior to operating and using the product. This requirement is only applicable for Germany. In other countries, other requirements might be applicable. Ask a qualified electrician to install the wall charging unit in accordance with the regulations applicable in your country.

### 4.3 Safety instructions

Please read the following safety instructions prior to using the product. All notes, specifications and warnings mentioned on the device as well as in the present operating manual must be imperatively respected and observed. The manufacturer BEKA Hospitec shall not accept any liability for any damages, failures or faults caused by improper operation or handling.



## 4.4 List of used safety instructions



Please observe the accompanying documents/operating manual.



Warning Hazardous Area.



Applied part "Type B" to DIN EN 60601-1.



Do not push/pull the motor.  
Do not push/pull the spreader bar.



Special waste, no household waste.  
The device and the packaging materials never must be disposed of in the domestic waste stream.



CE-label in accordance with the EC-Directive on Medical Devices.



Solely intended for indoor use.



Protection class II.

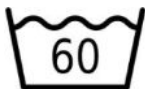

Washing temperature max. 60 °C.  
Normal cycle.



Do not bleach.



Line dry



Do not tumble dry.



Do not iron.





Professional wet clean.  
Gentle cycle.

## 4.5 Warnings

### Note

- Please read the operating manual and the safety instructions before starting to use the CARLO ALU. Keep the operating manual near the device for future reference.
- The product may only be used for the specified purpose.
- In case of unusual noises, damages or malfunctions, the product no longer must be used.
- The product may only be used and operated by trained staff.
- Check prior to each use that all visible parts are intact. Do not use the product if any part is damaged.
- The product must be disinfected after each use.
- Avoid slippery surfaces and thresholds.
- Do not move the lift over sloping or uneven floors.
- The CARLO ALU is exclusively fit for indoor use.
- Prior to each use of the device and its accessories, the user must check the functional safety and the good condition of the device and its accessories (e.g. visual check, functioning, etc.).
- Supervision of the caregiver is required throughout the treatment.
- Make sure that the sling form and size match the resident's body.
- Check prior to lifting that all clips or loops are correctly fixed to the spreader bar.
- Only trained staff is authorized to use slings.
- Please respect and observe the size and weight specifications for each sling.
- Check prior to each lifting operation whether the help of a second assistant is required.
- Each lifting or transport procedure must be adequately planned in order to ensure an optimal protection for the caregiver and the resident.
- Please check before and during the height adjustment procedure that your feet are not located in the area of the castors neither in the resident's area.
- Do not stand between the product and an obstacle during the transport procedure.
- During the movement of the product, the carrier frame must be closed.
- Please check that no one grabs in the hazardous areas (spreader bar, carrier frame) especially during the adjustment procedure - risk of crushing.
- Make sure that the resident is not hurt by the door frame when passing through doors.
- Do not lift the resident higher than is necessary.

- Activate the brakes of the castors of the wheelchair, the healthcare bed, the stretcher, etc. to ensure a safe lifting and positioning of the resident. The brakes of the CARLO ALU must be unbraked (released) during this operation.
- Keep the transport of the resident as short as possible and never leave the resident unattended in the sling.
- Never tilt or pull the resident beyond the fixing point of the spreader bar.
- Never exceed the duty cycle or the maximum load.
- Make sure that the battery is charged in a well-ventilated room.
- Do not use the product when the battery is charging.
- Make sure that the resident crosses the arms on the chest instead of holding on to the spreader bar.
- When applying the sling, make sure that the spreader bar does not touch the resident's head.
- Check the applied sling for visual damages prior to using it.
- Move the CARLO ALU by means of the handles provided to that effect instead of pulling the spreader bar.
- Never cover up, overstick or change the slots and holes of the device.
- Please check the proper state and the functional safety of the system prior to use. Never insert foreign bodies in the device.

<p><b>CAUTION</b></p> 	<p>In case of unusual noises, damages or malfunctions, the product no longer must be used.</p>
<p><b>WARNING:</b></p> 	<p>Any unauthorized repairs, modifications and additions are not permitted for safety reasons and exclude any liability of the manufacturer for resulting damage.</p> <p>For damages resulting from the use of spare parts or accessories not approved by the manufacturer, any further liability of the manufacturer is excluded.</p>
<p><b>Note:</b></p> 	<p>Repairs to components of the product are to be carried out only by trained expert personnel. Please contact the after-sales service.</p> <p>Opening the device or other accessories will lead to the expiration of all guarantee, warranty and liability claims.</p>

## 5 Transport

Use a lift truck or similar for the transport.

### 5.1 Unpacking the product

To remove the packaging materials, you will need a cutter knife.

<p><b>NOTE</b></p> 	<p>Take care so as to not damage the product when using tools. Do not cut with the cutter in the cardboard.</p>
--	---

#### 5.1.1 Removing the cardboard

**Proceed in the following way to remove the cardboard:**

- Cut the strap with the cutter knife
- Remove the strap
- Lift the cardboard up to remove it and put it aside

#### 5.1.2 Loosening the product from the pallet

The product is on both sides strapped to the pallet.

Proceed in the following way to loosen the product from the pallet:

- Unscrew the fixing screws of the straps
- Remove the straps
- Please take care not to damage the product when unscrewing the screws.
- Please make sure that the brakes of the castors are released.

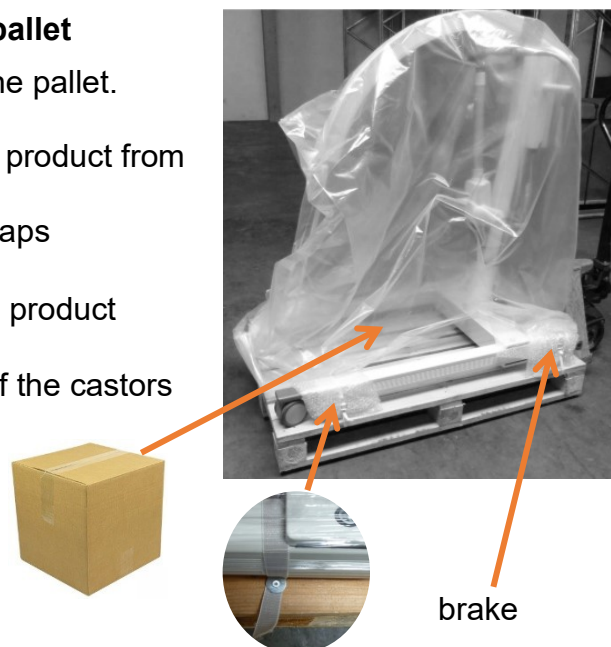

**After all fixations have been removed, you can remove the product from the pallet.**

The accessories for your product are included in the supplied cardboard box.

## 6 Installation

The product is supplied ready for use.



### 6.1 Electrical connection

Before you start to use our products, your electrical installation must be checked in accordance with the relevant VDE-regulations 0100 and 0100-710.

This requirement is only applicable in Germany. In other countries, other requirements might be applicable.

Ask a qualified electrician to install the wall charging unit in accordance with the regulations applicable in your country.

### 6.2 First start-up

<p><b>WARNING</b></p> 	<p>The equipment is to be used exclusively in accordance with the accompanying documents.</p> <p>Only when these conditions are met, the manufacturer considers himself responsible for the impact on the safety, the reliability and the function of the device.</p> <p>In the event of a new connection of the product, the technical data must be observed.</p>
<p><b>NOTE:</b></p> 	<p><b>The battery must be completely charged prior to the first use of the CARLO alu (charging time approx. 4 hours).</b></p> <p><b>Please check that the emergency stop switch is released prior to moving the spreader bar.</b></p>

The product is equipped with a 24V-electrical motor. This motor is self-locking and therefore protected against unintentional lowering of the spreader bar in case of malfunction or failure. The battery of the CARLO Alu must be completely charged before starting to use the device.

Please check that the emergency stop switch is released (unlatched). To unlatch, turn the emergency stop switch clockwise until it releases.

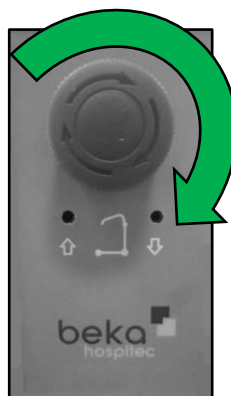

The emergency stop switch is released by turning the button to the right (i.e. clockwise).

## 7 Operating elements and their function

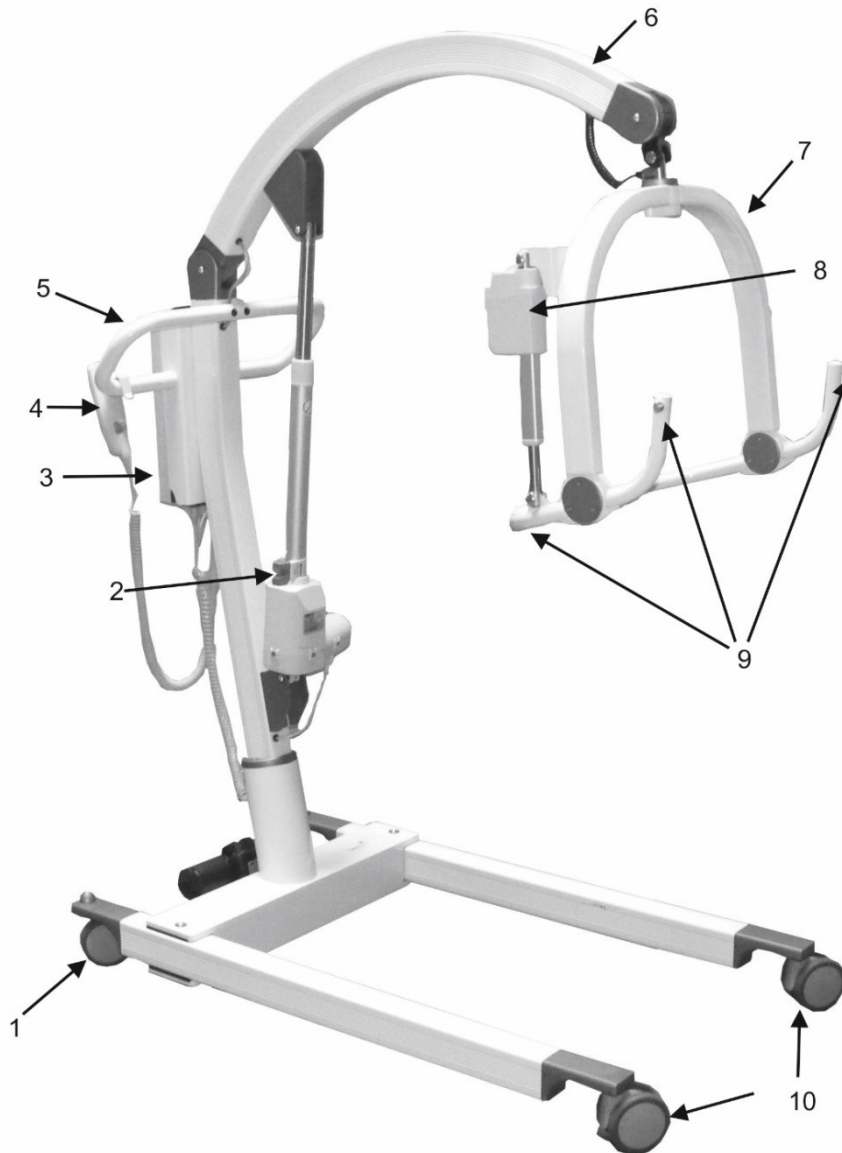

No.	Description	No.	Description
1	Rear castors with brake	6	Arm
2	Emergency lowering system	7	Spreader bar
3	Control unit with battery	8	Motor for the spreader bar adjustment (only EP)
4	Handset	9	Attachment point only for slings with clips <b>Caution: no slings with loops</b>
5	Spreader bar	10	Front castors

## 7.1 Classic Spreader Bar Version

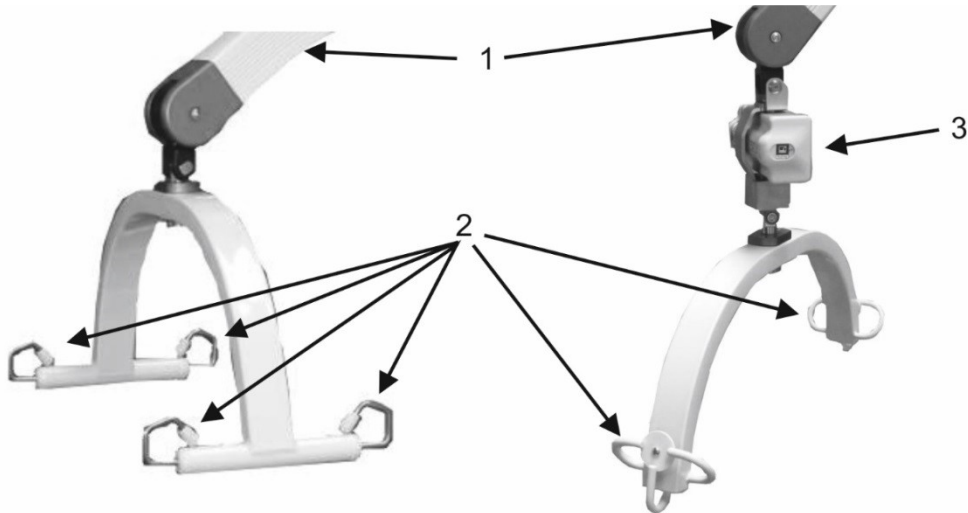

No.	Description	No.	Description
1	Arm	3	Scale, optionally available
2	Attachment points for slings with loops <b>Caution: no slings with clips</b>		

## 7.2 Handset

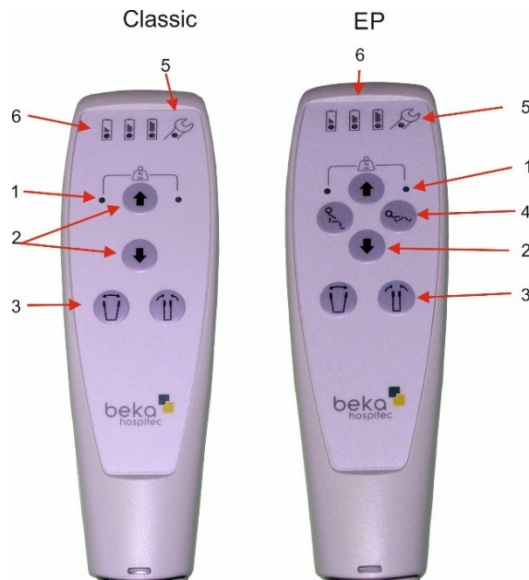

No.	Description	No.	Description
1	Overload	4	Only EP spreader bar, sitting and lying function
2	Spreader bar up/down	5	Service indication
3	Spreading the carrier frame	6	Battery charge level indication

## 7.3 Explanation of the LED-indications on the Handset



Green LED: battery full, no charging required (100-50%)



Yellow LED: battery requires charging (50-25%)



Red LED: battery requires charging (less than 25%)

When you push a button, an audible signal will be emitted.



Service indication (orange LED flashes).

Please have your stand-up and raising aid checked!

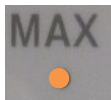

Orange LED, overload, max. weight of 185 kg exceeded

## 7.4 Connections and Functions of the Control Unit

### 7.4.1 7.3.1 European Control Unit

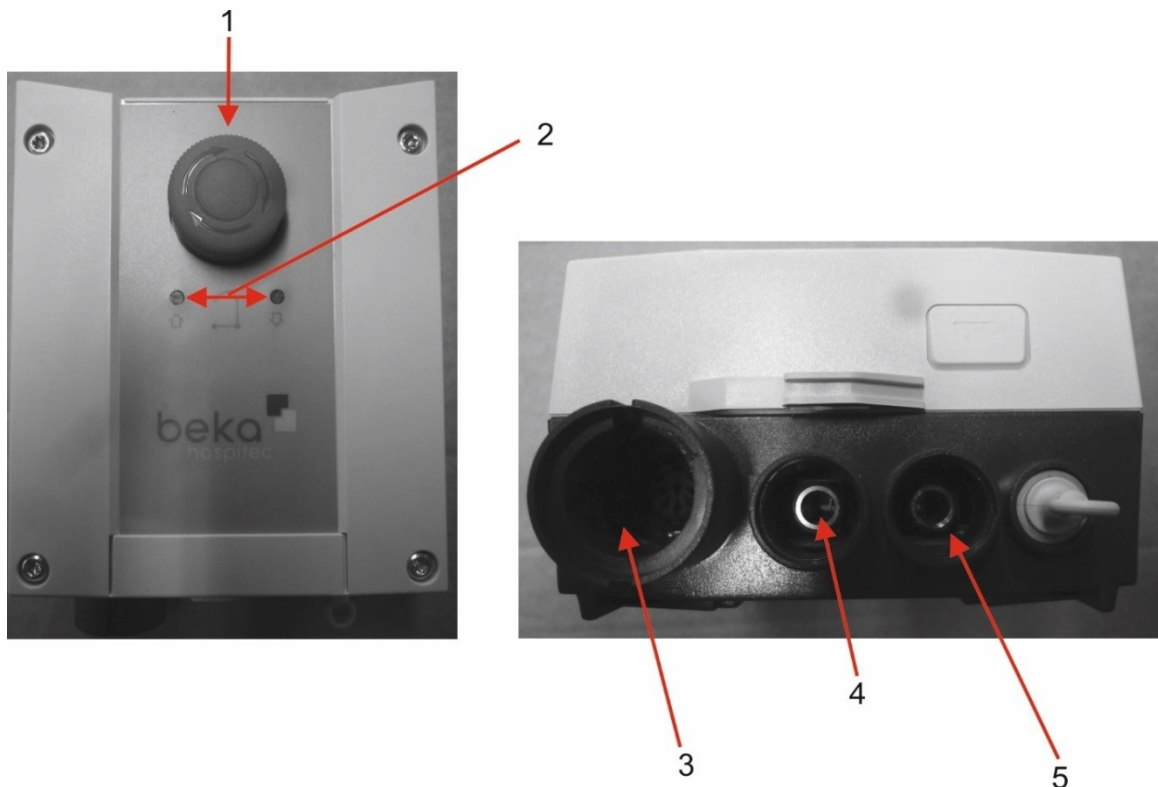

No.	Description	No.	Description
1	Emergency stop switch	3	Handset connection
2	Electrical emergency lowering (in case of malfunction of the handset)	4	Lifting motor connection
		5	Spreading motor connection



### 7.4.2 Canadian Control Unit

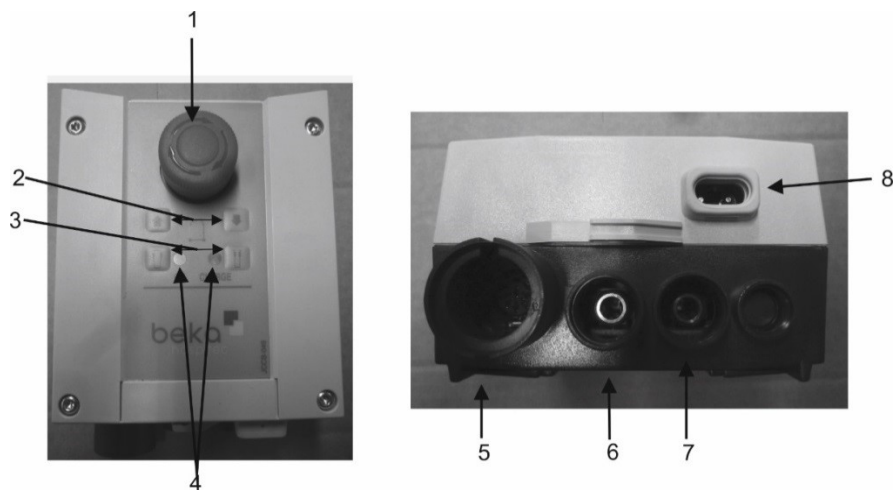

No.	Description	No.	Description
1	Emergency stop switch	5	Handset connection
2	Electrical emergency lowering (in case of failure of the handset)	6	Lifting motor connection
3	Adjustment of the spreading (in case of failure of the handset)	7	Spreading motor connection
4	Power and charging indicator	8	Charger cable connection

#### Explanation of the LED-indications



Green LED

The LED is on when the control unit is supplied with voltage through the power cable.



Yellow LED

The LED is on when the battery is charging.

Note: The battery can only be charged if the emergency stop switch is not actuated!

### 7.5 24V-Battery Unit

The CARLO ALU is equipped with a 24V-battery.

Please proceed as described in par. 13.7.4 to remove the battery.



## 7.6 External Charging Unit/Wall Charging Unit

The external charging unit (wall charging unit) is a switch-mode charger and is supplied ready assembled (on a mounting rail). It can be installed on any suitable wall. The required power cable is included in the delivery.

The charging time for the battery units is approx. 4 hours.

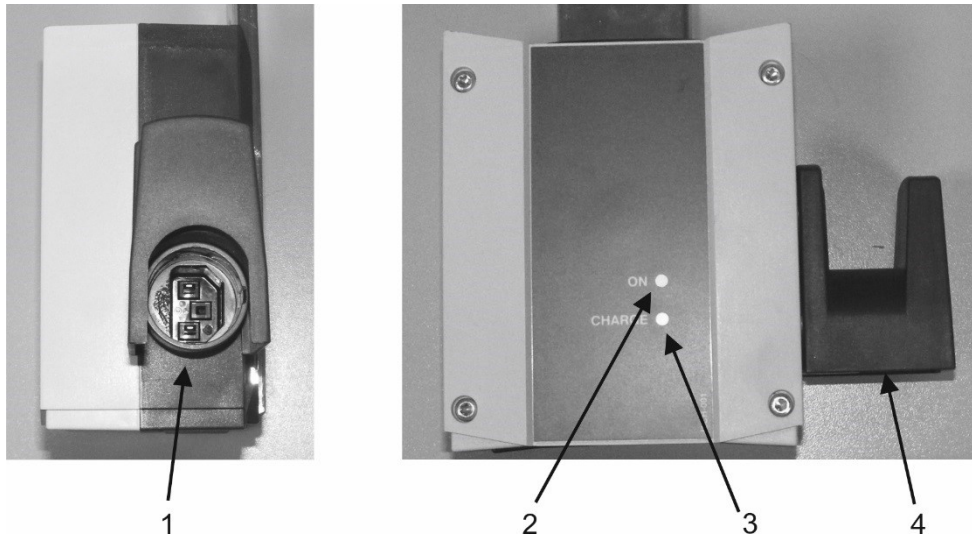

No.	Description	No.	Description
1	Mains input socket	3	Charging indicator (yellow LED)
2	Mains operation indicator (green LED)	4	Cable holder (optionally)

### Explanation of the LED-indications



Green LED

The LED is on when the control unit is supplied with voltage through the power cable.



Yellow LED

The LED is on when the battery is charging.

## 7.7 Manual Emergency Lowering System

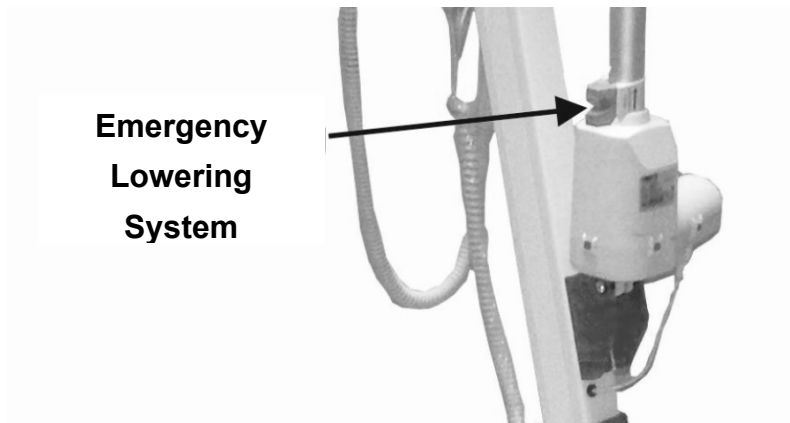

### Activating the Emergency Lowering System:

1. Slide the red safety lock upwards in the direction of the arrow (PULL-EMERGENCY label).
2. Now, the motor is lowering slowly (lowering weight approx. 20 kg).
3. The motor stops, when the safety lock is positioned back in its normal position = release the safety lock.

#### Note:

The emergency lowering mechanism must not be treated with oil, grease or any other lubricant, as this could cause the emergency lowering mechanism to run too smoothly! In case of a failure of the emergency lowering system, a reset at the manufacturer's is required.

## 7.8 Electrical emergency lowering

Should your handset be defective or present a malfunction and provided that the battery still has sufficient voltage, you can raise or lower the spreader bar by means of the buttons located on the control unit.

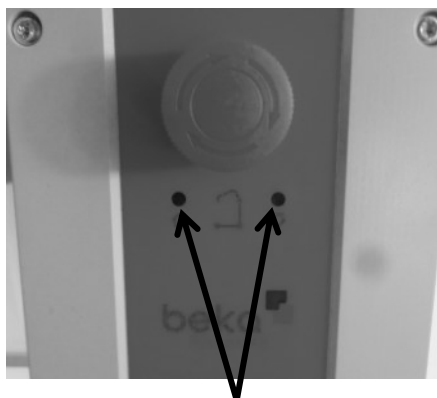

Buttons of the control unit (European version)

Insert a ballpoint or a similar object into the holes to actuate the buttons. The spreader bar is raised or lowered.

Note:

The buttons of the Canadian version of the control unit can be activated manually.

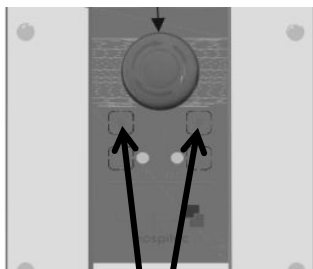

Buttons of the control unit (Canadian version)

### 7.9 Emergency stop switch

When the emergency stop switch is pressed, the electrical motors are immediately disconnected from the power supply. The motor stops immediately. The emergency stop switch should be used only in case of immediate danger to the resident or the caregivers.

The emergency stop switch can also be used to reduce discharging of the battery in case of intermediate storage.

By pressing the emergency stop switch, you can lock the CARLO ALU sling hoist, thus making any unauthorized use of the sling hoist more difficult.

Turn the button in the direction of the arrow to unlock.

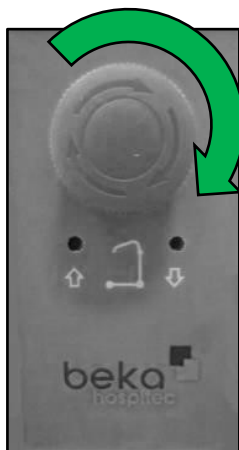

**NOTE:**



**In the Canadian version of the control unit, the battery can only be charged when the emergency stop switch is not actuated!**

## 7.10 Motor Safety Measures

The control of the electrical motor is equipped with an overload protection, which is autonomously switched off in case of overload. The motor will only be operational again after a short waiting time. The cooling-off time of the motor can be up to 18 minutes depending on the ambient temperature.

**NOTE:**

**Opening the motor will result in expiration of the warranty.**

**The intermittent operation of the motor is not a defect, but is only for your own safety.**

## 7.11 Impact and Jamming Protection (hoist motor)

The electrical motor (hoist motor) features an integrated impact and jamming protection (freewheeling). This feature avoids jamming, pinching and/or crushing dangers when the spreader bar of the CARLO ALU strikes or encounters an obstacle. The motor runs free until the obstacle is removed or the CARLO ALU is moved away from the obstacle.

After the obstacle has been removed, the spreader bar could start lowering autonomously. Therefore, you must immediately release the button of the handset as soon as you have noticed that an obstacle has been encountered.

# 8 Operation

## 8.1 Sling Operating Manual

### Important note:

The normal service life of BEKA-slings is approx. 36 months from the date of production (marked on the sling). The specified service life is only applicable, when the BEKA-slings are cleaned, maintained and inspected in accordance with the instructions contained in the following documentation.

### 8.1.1 Prior to Use

The slings must be checked before and after each use and, if necessary, be washed in accordance with the manual. This is prescribed in particular to reduce the risk of infections to an absolute minimum, in the event that the same equipment is used for other residents or patients.

Prior to each use, a thorough check of the sling including the loops and the fastening clips is imperatively required. If the sling or the loops would be frayed, cut-in or damaged, or the clips would be damaged, the sling no longer must be used.

Please make sure that a sling of the correct size is used for the resident.

Prior to lifting the patient or the resident, the situation must be assessed by a qualified employee or a therapist. This also applies to care-dependent persons with limited or reduced shoulder mobility or for patients who are unable to hold themselves with one or both hands.

### 8.1.2 During Use

Check that the sling fittings at the sling hoist match the sling clips.

The use of incompatible (i.e. non-BEKA Hospitec) slings can cause accidents!

Check that the sling is not twisted when attaching the sling. Always check that the sling clips are correctly attached prior to and during the lifting procedure and that they are tensioned while supporting the patient's weight. Check that the sling is not too tight and that the patient's arms are inside the sling.

#### 8.1.2.1 Safe Attachment of the Clips in the Support



**Always check that the fastening clips are secured and correctly positioned prior to lifting the patient/resident!**

### 8.1.2.2 Safe Suspension of the Sling in the Support

#### 4-point Classic spreader bar

4-point Classic spreader bar:

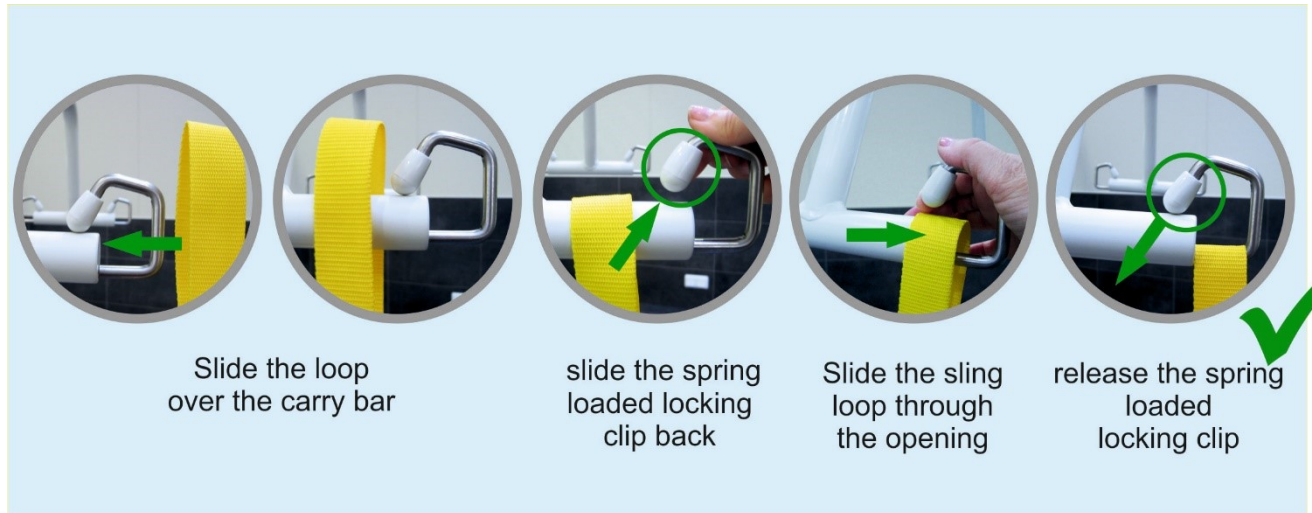

**Check that the loops are secured and correctly positioned prior to lifting the patient/resident!**

#### 6-point Classic spreader bar

6-point Classic spreader bar:

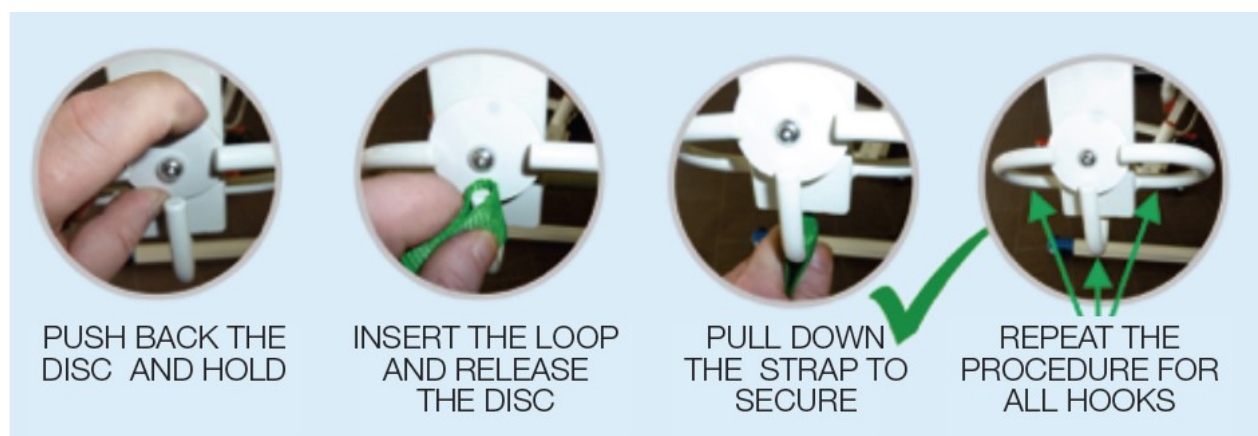

**Check that the loops are secured and correctly positioned prior to lifting the patient/resident!**

### 8.1.2.3 Applying the BEKA Hospitec Sling in Sitting Position

#### **Caution:**

Lead the sling with your hand downwards to the sitting surface so that the bottom of the sling is aligned with the coccyx (butt bone).

Make sure that the patient's head is located inside the cloth.

It is easier to apply the sling, when the patient leans slightly forward.

Pull the leg loops forward so that they are on the outside of the thigh. Make sure that the leg loops protrude equally.

**Pull on the left and the right side of the leg loops to straighten possible folds or wrinkles.**

Pull the leg loops one by one under the patient's thigh. Check that the sling is completely wrapped around the thigh without wrinkles or folds.

#### **Caution:**

Now, you can attach the leg loops to the CARLO ALU either crosswise or parallel (only for loop slings), always one to the right and the other to the left of the hanger bar. Attach in any cases the 2 shoulder fixations as well as the 2 fixations for the legs to the CARLO ALU.

#### **For 4-point Suspensions with Safety Clips for the 4-point Suspension:**

Never suspend the leg loop crosswise!

Always suspend individually with the safety clips to the 4-point spreader bar.

### 8.1.2.4 Applying the BEKA Sling in Lying Position

1. Turn the patient so that he/she is facing you. Fold the sling lengthways together and position the sling sideways as close as possible to the patient/resident. Make sure that the extremity of the sling is located at the height of the coccyx. Turn the resident/patient to the other side and pull the sling completely apart. Lift the headboard of the bed slightly up.
2. Insert the leg loop under the thigh. This is facilitated, when the patient's knee is bent. Check once more that the leg loops are completely wrapped around the thigh.
3. Make sure that the patient's head is located inside the cloth.
4. Fix the lifting loops in the shoulder area and then fix the leg loops. Slings with safety clips must be clipped into the fixing points of the sling hoist provided to this effect. Lift the patient/resident.

#### **NOTE:**



**To avoid injuries, the arms and the head of the patient/resident must be *inside* of the sling.**



### 8.1.2.5 Manual for the Toilet Sling

**Caution:**

**The non-observance of the following instructions could cause injuries to other persons or to yourself.**

Always check that the patient/resident has sufficient self-control over his/her head and body to be lifted safely with a toilet sling. In case of doubt: use another suitable sling.

in order to have optimal access to the patient during the visit to the toilet, the toilet sling is equipped with an extremely large butt opening; as a consequence, you should pay particular attention that:

- a. The appropriate sling size for the body weight and body size of the patient/resident is chosen, and
- b. Both arms of the patient/resident are located outside of the sling, above the upholstered arm-pit area, but underneath the fixations of the loops for the head support area.

In case of a correct operation, this prevents the patient/resident from slipping through the butt opening.

Apply the toilet sling to the patient/resident so that the head support area of the sling is at the same height as the patient's/resident's head. The bottom part of the sling is fixed at approx. the height of the patient's hips, depending on his/her body size.

Always make sure that the sling clips (for loop slings, the loops) are safely and securely fixed to all points of the spreader bar provided to this effect, prior to lifting the patient/resident. Slowly raise the CARLO ALU in order to be able detecting and correcting immediately possible incorrect fixations.

**Note:**

We recommend opening the buckles of the head area prior to applying the sling and to close them again after the sling has been applied. Make sure that the patient's/resident's arms are located outside of the sling and over the upholstered arm-pit area.

Always make sure that the patient/resident is in an upright sitting position when he/she is being lifted and transferred with the CARLO ALU.

If you respect and observe these instructions, the toilet sling will be an efficient aid for the toilet visit.

### 8.1.3 After Use

For the washing, the slings are classified as accessory and therefore as medical device. The slings may be cleaned and disinfected in accordance with the manufacturer's instructions.

During the washing and drying, no mechanical pressure must be applied, such as dry press, rotary iron. This could damage the sling parts and impair the operation and the safety of the sling or even destroy the sling.

The sling loops must be checked and, if required, cleaned after each use. The washing temperatures must not exceed the temperature specified on the sling. Please use common household detergents only. Do not iron hot. The plastic clips must be checked for possible damages after each wash.

## 8.2 Operation of the CARLO Alu

The spreader bar of the CARLO Alu sling hoist is raised or lowered by means of the handset, which is included in the delivery. The direction of motion is indicated by symbols. The rear castors have (ease-to-operate) brakes. When lifting a patient/resident, the brakes of the castors must be activated to avoid any uncontrolled movement of the CARLO Alu.

### Travel path

When using the CARLO Alu, make sure that the travel path of the CARLO Alu is not narrowed by obstacles or other elements (e.g. wall racks, etc.). Remember also that the maximum height is limited to 2175 mm. Take extreme care when passing through door frames.

### 8.2.1 Explanation of the Functions of the Handset

The different functions of the CARLO Alu can be activated by means of the handset.

#### ***Raising and Lowering the Spreader Bar***

Keep the button  of the handset pressed to raise the spreader bar. The spreader bar is raised. Release the button as soon as the spreader bar has reached the desired position. The upward movement of the spreader bar is stopped.

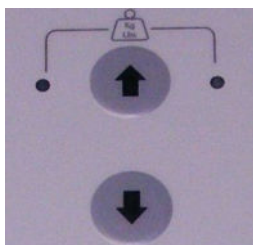

When the highest possible position is reached, the upward movement is automatically stopped.

Keep the button  of the handset pressed to lower the spreader bar. The spreader bar is lowered. Release the button as soon as the spreader bar has reached the desired position. The downward movement of the spreader bar is stopped.

When the lowest possible position is reached, the downward movement is automatically stopped.

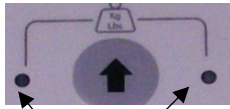

Display maximum weight

If the LED-indication “MAX” is displayed the highest possible load capacity of the CARLO Alu is reached. In such case, lower the patient and use another sling hoist with a higher load capacity.

**Spreading of the Carrier Frame**



Keep the button of the handset pressed to spread the carrier frame. The carrier frame of the CARLO Alu is spread. Release the button as soon as the desired spread width is reached. The spreading movement is stopped. When the maximum spreading position is reached, the movement is automatically stopped.



Keep the button of the handset pressed to close the carrier frame. The carrier frame of the CARLO Alu is closed. Release the button as soon as the desired spread width is reached. The spreading movement is stopped. When the minimum spreading position is reached, the movement is automatically stopped.

The spreadable carrier frame highly increases the stability of the sling hoist.

**Tilting the Spreader Bar (only possible with EP spreader bar)**



Keep the button of the handset pressed to change the sitting position of the patient/resident. The spreader bar is tilted backwards, thus bringing the patient/resident into a lying position. Release the button as soon as the desired position is reached. The tilting movement is stopped. When the end position is reached, the tilting movement is automatically stopped.



Keep the button of the handset pressed to set the spreader bar back upright. The spreader bar is tilted forwards, thus bringing the patient/resident into a sitting position. Release the button as soon as the desired position is reached. The tilting movement is stopped. When the end position is reached, the tilting movement is automatically stopped.

## 8.2.2 Lifting a patient/resident

Proceed in the following way to lift a patient/resident from a chair:

1. Apply the sling in accordance with the operating manual.
2. Position the CARLO Alu (without suspended sling) with the carrier frame spread aside the patient/resident.
3. Slide the sling downwards at the back of the sitting patient/resident. Pull the leg loops forward and lift one leg at the time. Bring the leg loops under the patient's/resident's leg. Check that the shoulders and the head of the patient/resident are correctly positioned in the sling. Particularly make sure that the patient's head is located inside the sling.
4. Use the lifting arm to bring the spreader bar in a position, which enables you to attach the loops or clips to the attachment points. If your CARLO is equipped with an EP spreader bar, you possibly must change the position of the hanger bar to be able reaching the attachment points.
5. Suspend the sling to the lifting eye. Check that the sling is correctly fixed. The sling hoist has 4 or 6 fixing points (depending on the spreader bar type) to enable an individual adjustment to each patient/resident.
6. Activate the brakes of the rear castors.
7. You can now raise the patient/resident.
8. If your CARLO is equipped with an EP spreader bar, you can change the position of the spreader bar if needed to bring the patient from a lying into a sitting position.
9. Close the carrier frame. The lowering of the CARLO is enhanced when the carrier frame is not spread.
10. Release the brakes of the rear castors.
11. You can now transfer the patient to the desired location with the CARLO. To move the sling hoist, push or pull the handles provided to this effect. Do not push or pull the sling hoist or the cylinder bar of the motor.

### 8.2.3 Putting the patient/resident down

When you have reached the desired location, you can put the patient/resident e.g. on a chair or in bed. Proceed in the following manner:

1. Spread the carrier frame if needed up to the maximum possible spread width.
2. Bring the CARLO with the patient/resident over the intended location.
3. If your CARLO is equipped with an EP spreader bar, you can change the position of the spreader bar if needed to bring the patient from a lying into a sitting position.
4. Check that the chair or the bed stands safely; activate the brakes of the wheelchair if required.
5. Lower the lifting arm with the spreader bar until the patient/resident sits safely in the chairs or lies safely on the bed and the loops of the sling are relieved.
6. Remove the loops or the clips of the sling from the spreader bar.
7. Pull the CARLO away from the patient. Make sure to pull the CARLO straight backwards to avoid injuring the patient with the spreader bar. If required, raise the spreader bar to avoid injury of the patient/resident.
8. Put the CARLO at a safe location.
9. Remove the sling from the patient/resident.

**Caution:**

**The CARLO is exclusively fit for indoor use.**

**Caution:**

**Do not move the CARLO over sloping or uneven floors.**

**Warning:**

**Make sure that the CARLO is not tilted over 5° when driving over thresholds or similar. The CARLO could fall over in this case!**

## 8.3 Digital scale SLS (option)



To operate the scale, refer to the operating instructions of the scale.

## 8.4 Maintenance and Care of the 24-Volt Battery

The battery and the control box must not be opened by the customer.

Repairs may be carried out only either by BEKA Hospitec or by companies authorized to this effect by BEKA Hospitec. If the battery is discharged, recharge it as soon as possible to extend the lifetime. Batteries stored in the warehouse/stock must be recharged every 6 months (a possible deep discharge may destroy the battery). The battery's lifetime basically depends on the charge (number of lifting cycles) and the charging state. It can be up to 5 years. Have defective or worn out batteries, and defective charging units in general, replaced.

## 9 Cleaning/Disinfection

<p><b>CAUTION</b></p> 	<p>Make sure that the system is not in operation during the cleaning activities.</p>
<p><b>CAUTION</b></p> 	<p>After each treatment, the product must be completely disinfected with a disinfectant. In this way, any cross-contamination is avoided.</p>
<p><b>CAUTION</b></p> 	<p>Only use the disinfecting system after the patient has left the product. Strictly respect and observe the manufacturer's instructions for the used disinfectant. Avoid direct contact with the concentrated product. If necessary, use gloves and safety glasses to protect your skin and eyes..</p>

### 9.1 Cleaning the lift

Clean the product with a soft, lint-free cloth, moistened with soapy water or a standard plastic cleaner. Please do not use abrasives to clean the lift!

To avoid damages, **no** aerosol cleaners, sprays, abrasive cleaners or solvents must be used to clean the keypad.

Please remember that all warranty claims regarding surface damage will not be accepted, if aggressive cleaning agents are anyhow used.

## 9.2 Disinfecting the lift

You must carefully disinfect and rinse your product after each use to avoid the risk of transmission and infection. For the manual disinfection of the surface, an isopropyl alcohol solution or a customary disinfection aerosol (spray) can be used.

## 9.3 Sterilising the lift

The lift CARLO is **not** suitable for sterilization.

# 10 Checks/tests

In order to ensure a safe use of our product and the protection of the users and the patients, BEKA Hospitec prescribes an annual safety check. The execution of the safety checks and maintenance must be documented and proven on request. Please use your inventory register to this effect. We recommend a simultaneous maintenance of the device in order to conserve its full value.

The checks may only be conducted by the manufacturer either by specialists authorized by the manufacturer. Please contact the manufacturer upon expiration of the validity date mentioned on the inspection sticker located on the rear side of the device.

<p><b>NOTE</b></p> 	<p>In accordance with the UVV (accident prevention) regulations of the German employer's liability insurance association on stationary equipment which is used in special locations or installations, an annual check to the DGUV (German Statutory Accident Insurance Association) Prescription 3 (BGV A3) must be carried out on the product.</p>
--	---

This check is only prescribed for Germany. In other countries, other requirements might be applicable.

<p><b>WARNING</b></p> 	<p>Do not conduct any cleaning, maintenance or test activities when the product is in use. This could cause danger to the user and the patient.</p>
---	---

Conduct a **daily** cleaning and disinfection of the product.  
 Conduct a **weekly** visual inspection of all components, the power cable, the hoses and the connections. Conduct a functional test as well.  
 Conduct **every year** a maintenance, a safety check and a check to DGUV prescription 3.

## 10.1 Prior to each use

To ensure a safe and failure-free operation, the following checks must be carried out prior to each use:

- Visual check of the CARLO ALU (external damages and wear-and-tear).
- Check that no screws of the CARLO ALU are missing or loose.
- Check the proper functioning of the CARLO ALU.
- Check the proper functioning of the spreader bar.
- Check the proper functioning of the handset (up/down, spreading, spreader bar inclination)
- Check the emergency lowering system.
- Check the smooth running of the castors.
- Check the slings for damages.
- Check the state of charge of the battery

## 11 Waste disposal

### 11.1 Disposal of the packaging material

Please recycle the packaging materials of the product in accordance with the locally applicable regulations and laws. The metal parts as well as the plastic and electronic components must be recycled in accordance with the WEEE.

### 11.2 Disposal of the product

At the end of the product's lifetime, contact your BEKA dealer, who will recycle the product in accordance with the locally applicable regulations and laws.

For an environmentally-sound disposal, the company BEKA Hospitec GmbH will provide more information in its capacity of manufacturer.

Please clean and disinfect the product prior to its disposal as well.



## 12 Troubleshooting/After-sales service

### 12.1 Troubleshooting help

Problems with the Sling Hoist	Remedy
The travel adjustment and the spreading of the carrier frame of the CARLO do not function.	<ul style="list-style-type: none"> <li>a) Check if the emergency stop switch is released/pressed.</li> <li>b) Check that the cables of the control box are correctly connected.</li> <li>c) Check the battery's state of charge.</li> <li>d) Remove the battery pack and check the contacts for damage.</li> </ul>
The CARLO remains in the top end position.	<ul style="list-style-type: none"> <li>a) Check if the emergency stop switch is released/pressed.</li> <li>b) Check the battery's state of charge.</li> <li>c) Use the electrical emergency lowering feature to lower the patient/resident.</li> <li>d) Use the mechanical emergency lowering feature to lower the patient/resident.</li> </ul>
The carrier frame motor does not run.	<ul style="list-style-type: none"> <li>a) Check if the emergency stop switch is released or pressed.</li> <li>b) Check that the control box is correctly plugged in.</li> <li>c) Check the battery.</li> </ul>
The drive stops during the lifting procedure.	<ul style="list-style-type: none"> <li>a) Battery low. <b>Charge the battery.</b></li> <li>b) The maximum load is exceeded (max. patient weight).</li> </ul>
The electrical positioning system does not respond.	<ul style="list-style-type: none"> <li>a) Make sure that the handset is connected.</li> <li>b) Check the plug-in connector at the control box.</li> <li>c) Check the battery.</li> </ul>
The control box emits a "beep" signal when operated.	<p style="text-align: center;">Battery low. <b>Charge the battery.</b></p>
The handset does not work.	<ul style="list-style-type: none"> <li>a) Check the connectors at the handset cable and the motors.</li> <li>b) Check the battery's charging state (replace with fully charged battery).</li> </ul>
The up and down buttons of the handset do not respond.	<ul style="list-style-type: none"> <li>a) Check if the emergency stop switch is released or pressed.</li> <li>b) Check the battery's charging state (replace with fully charged battery).</li> <li>c) Check that the cables of the control box are correctly connected.</li> </ul>
The castors produce loud noises.	<p style="text-align: center;">Clean castors if necessary. Replace if necessary.</p>

The CARLO produces unusual noises.	Inform the after-sales service.
The CARLO is damaged.	Inform the after-sales service.
The "Service" indication is lit.	The annual check must be carried out.
<b>Problems with the Charging Unit</b>	<b>Remedy</b>
The charging unit does not work.	a) Remove the battery pack and check the contacts for damage. b) Check the mains plug.
The operating display of the charging unit is not lit.	a) Check that the charging unit is connected to a power outlet. b) Check the power outlet fuse.
The charging unit is connected to the power outlet, but the operating display is not lit.	a) Check that the wall outlet is supplied with power. b) Remove the battery and check for damage.
<b>Problems with the Battery</b>	<b>Remedy</b>
The battery is placed correctly, but the indicator lights are not lit.	Inform the after-sales service.
The indicator light does not go out after multiple hours of charging.	The battery must be replaced. Inform the after-sales service.
The battery installed in the charging unit indicates that it is fully charged. However, when placed in the CARLO, just a few lifting cycles are possible.	The battery must be replaced. Inform the after-sales service.
When the handset is actuated, an acoustic signal is emitted and the indicator light (red) is on.	Check the battery's charging state.

When your bath tub does not function properly and you cannot eliminate the error by means of the remedies listed in paragraph 12 please contact the after-sales services of your dealer either the manufacturer.

	BEKA Hospitec GmbH Am Rübenmorgen 3 35582 Wetzlar Phone: +49(0)641-9 22 22-0 Fax: +49(0)641-9 22-22-20 info@beka-hospitec.de
---	---

# 13 Appendix

## 13.1 Technical data

<b>Dimensions and weights</b>	
- Length:	129.0 cm
- Width in closed condition:	70.0 cm
- Width in open condition:	118.0 cm
- Min. height:	134.0 cm
-Max. height:	217.0 cm
- Travel with hanger bar:	20.0 - 158.0 cm
- Travel without hanger bar:	68.5 - 208.5 cm
- Weight without packaging:	Approx. 55 kg depending on the variant
- Safe Working Load (SWL):	<b>max. 185 kg</b>
- Turning Radius	135,0 cm
<b>Electrical data</b>	
- Power Supply	24 Volt Battery
-max. Power Consumption:	10A = 240VA
- Applied part:	Type B
- Duration of treatment:	10%, 2 min. continuous operation, 18 min. pause
- Protection class:	IPX 4
<b>Ambient conditions</b>	
<b>Operation</b>	
- Temperature range:	10° C to 40° C
- Relative humidity:	30% to 75%, non-condensing
- Atmospheric pressure:	800 – 1060 hPA
<b>Storage and transport</b>	
- Temperature range (stand-up and raising aid):	-40° C to 70° C
- Temperature range (battery):	-15° C to 40° C
- Relative humidity:	10% to 80%, non-condensing
- Atmospheric pressure:	500 – 1100 hPA

**External wall charger:**

- Power Supply	100V – 240 V ~ (AC) /50 /60 Hz
- Power Output:	24 V (DC)
- current consumption:	I in max. 400 mA
- Fuse:	T1,25 A / 250V
- Protection class:	IPX 5

**Battery:**

- battery type	Lead acid battery
- Power Output:	24 V (DC)
- capacity:	2,9 Ah
- Output current:	Iout max 10A
- Protection class:	IPX 5

**Additive for control box with integrated charger**

- Power Supply	100V – 240 V ~ (AC) /50 /60 Hz
- Power Output:	24 V (DC)
- current consumption:	I in max. 400 mA
- max. Power consumption:	10 Watt
- Fuse:	T1,25/250V

## 13.2 Dimensions CARLO Alu Classic 185 / EP 185

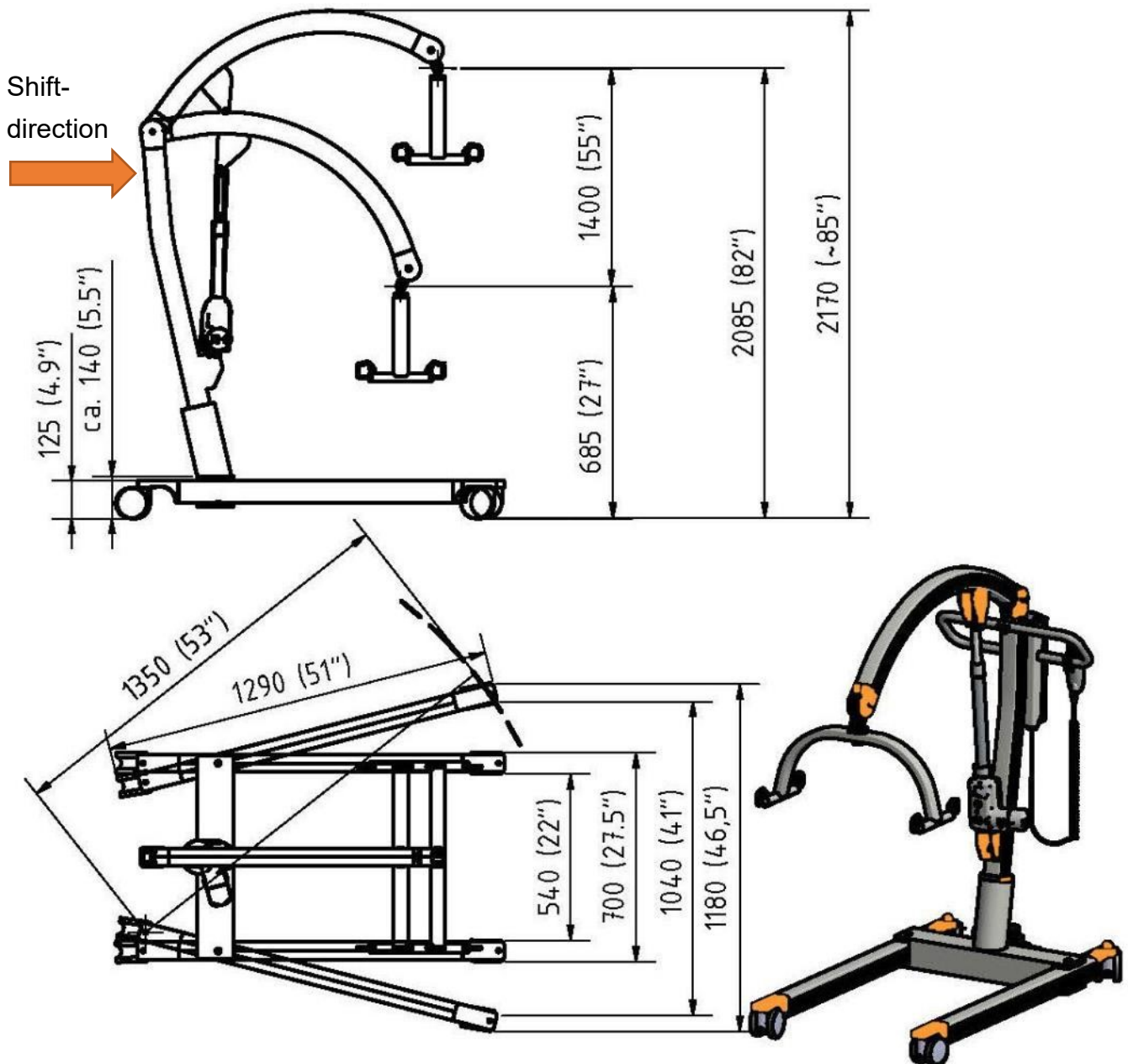

Note: Depending on the hanger bar used and the use of the optionally available scale, the distance from the floor to the sling suspension is different!

## 13.3 Declaration of Conformity



### EG-Konformitätserklärung / EC-Declaration of Conformity

Der Hersteller / The manufacturer

**BEKA Hospitec GmbH**  
**Am Rübenmorgen 3**  
**D-35582 Wetzlar-Dutenhofen**

erklärt in alleiniger Verantwortung gemäß EG-Richtlinie für Medizinprodukte 93/42/EWG Annex VII,  
dass die folgenden Produkte

*declares under sole responsibility according to the EU Medical Device Directive 93/42/EEC, Annex VII that  
the following products*

CARLO Alu (Classic 185)	Artikel Nr. - P/N.	924003100, 924003200, 924002008, 924002018, 924003208, 924003218
CARLO Alu (Classic 230)	Artikel Nr. - P/N.	924001500, 924001508, 924001518, 924003008, 924003018
CARLO Alu (Comfort GPL)	Artikel Nr. - P/N.	925001000, 925001008, 925001018
CARLO Alu (Comfort EP 185)	Artikel Nr. - P/N.	925006000, 925006008, 925006018
CARLO Alu (Comfort EP 230)	Artikel Nr. - P/N.	925007000, 925007008, 925007018
CARLO Eco (Classic 185)	Artikel Nr. - P/N.	924003700
CARLO Eco (Classic 205)	Artikel Nr. - P/N.	924003750
CARLO Eco (EP 185)	Artikel Nr. - P/N.	924003800
CARLO Eco (Comfort EP 205)	Artikel Nr. - P/N.	924003850

den grundlegenden Anforderungen entsprechen und die Voraussetzungen für die CE-Kennzeichnung erfüllen.  
*comply with the essential requirements and fulfill the provisions of CE marking.*

Die Bauart der Produkte entspricht Klasse I des Medizinproduktegesetzes (MPG), Regel 12.  
*The products correspond with Class I Medical Device Directive (MDD), Rule 12.*

Zur Beurteilung wurden folgende Normen / Richtlinien herangezogen:  
*The following standards / directives apply:*

EG-Richtlinie 93/42/EWG/ Directive 93/42/EEC		DIN EN ISO 14971:2013
DIN EN 10535:2007		DIN EN 60601-1:2007
DIN EN 12182:2012		DIN EN 60601-1-2:2007

Diese Erklärung trifft auf alle Produkte zu, die nach Ausstellung dieser Erklärung produziert wurden, bis sie  
durch eine andere Erklärung ersetzt wird.

*This declaration applies to all CE marked devices manufactured from the date of its issuance on until it is  
either superseded by another declaration or withdrawn.*

**Technische Änderungen vorbehalten / Technical changes reserved.**

Wetzlar, den 02.05.2018

Robert Deschler  
Geschäftsführer

BEKA Hospitec GmbH  
Am Rübenmorgen 3  
D-35582 Wetzlar-Dutenhofen  
Fon 0841 / 92 22 0-0  
Fax 0841 / 92 22 0-20

USt.-IdNr.: DE278603356  
Amtsgericht Wetzlar, HRB 6207  
info@beka-hospitec.de  
www.beka-hospitec.de

Geschäftsführung  
James Stuart-Smith  
Robert Deschler



Commerzbank AG Wetzlar  
Konto-Nr.: 482176500  
BLZ: 515 400 37  
IBAN: DE60515400370482176500  
SWIFT-BIC: COBADEFF515

## 13.4 Accessories of the Sling Hoists CARLO Alu Classic 185Kg

<b>Basic device</b>			
Description	Article number	Description	Article number
CARLO Alu, Classic 185 Incl. 4-point spreader bar (Only for slings with loops)	924003100	CARLO Alu Classic 185 Incl. 6-point spreader bar (only for slings with loops)	924003200
	924002008		924003208
	924002018		924003218
<b>General accessories</b>			
Spare battery 24V	921070602	Wall charger	921070702

<b>Slings with loops Europe</b>		
Description	Size	Article number
Nylon transfer sling	Size "S"	923003100
Nylon transfer sling	Size "M"	923003200
Nylon transfer sling	Size "L"	923003300
Nylon transfer sling	Size "XL"	923003400
Nylon transfer sling	Size "XXL"	923003500
Bathing sling	Size "S"	923004100
Bathing sling	Size "M"	923004200
Bathing sling	Size "L"	923004300
Bathing sling	Size "XL"	923004400
Bathing sling	Size "XXL"	923004500
Nylon toilet sling	Size "M"	923005200
Nylon toilet sling	Size "L"	923005300
Nylon toilet sling	Size "XL"	923005400

<b>Slings with loops US/ Canadian version:</b>		
Description	Size	Art. N°
Nylon transfer sling	Size S	923003103
Nylon transfer sling	Size M	923003203
Nylon transfer sling	Size L	923003303
Nylon transfer sling	Size XL	923003403
Nylon transfer sling	Size XXL	923003503
Bathing sling	Size S	923004103
Bathing sling	Size M	923004203
Bathing sling	Size L	923004303
Bathing sling	Size XL	923004403
Bathing sling	Size XXL	923004503
Nylon toilet sling	Size S	923005103
Nylon toilet sling	Size M	923005203
Nylon toilet sling	Size L	923005303
Nylon toilet sling	Size XL	923005403
Nylon toilet sling	Size XXL	923005503

Transfer sling with loops	Description	Guideline for sling sizes		
	made of nylon washable at max. 60°C	<b>Size</b> S M L XL XXL	<b>Weight</b> 35-65 kg 55-85 kg 75-125 kg 120-160 kg 160-210 kg	<b>Color</b> red yellow green blue orange
Bathing sling with loops	Description	Guideline for sling sizes		
	made of nylon washable at max. 60°C	<b>Size</b> S M L XL XXL	<b>Weight</b> 35-65 kg 55-85 kg 75-125 kg 120-160 kg 160-210 kg	<b>Color</b> red yellow green blue orange
Toilet sling with loops	Description	Guideline for sling sizes		
	made of nylon washable at max. 60°C	<b>Size</b> S M L XL XXL	<b>Weight</b> 35-65 kg 55-85 kg 75-125 kg 120-160 kg 160-210 kg	<b>Color</b> red yellow green blue orange



## 13.5 Accessories CARLO Alu Comfort EP 185

Basic device			
Description	Article number		
CARLO Alu Comfort EP 185 Incl. 4-point spreader bar (Only for clip slings)	925006000 925006008 925006018		
General accessories			
Spare battery 24V	921070602	Wall charger	921070702

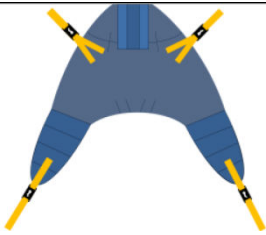
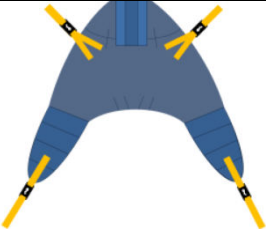
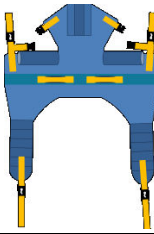

<b>Slings with clips Europe</b>		
<b>Description</b>	<b>Size</b>	<b>Article number</b>
Nylon transfer sling	Size "S"	922005100
Nylon transfer sling	Size "M"	922005200
Nylon transfer sling	Size "L"	922005300
Nylon transfer sling	Size "XL"	922005400
Nylon transfer sling	Size "XXL"	922005500
Bathing sling	Size "S"	922006100
Bathing sling	Size "M"	922006200
Bathing sling	Size "L"	922006300
Bathing sling	Size "XL"	922006400
Bathing sling	Size "XXL"	922006500
Nylon toilet sling	Size "M"	922007200
Nylon toilet sling	Size "L"	922007300
Nylon toilet sling	Size "XL"	922007400
Nylon sling for double leg amputees	Size "S"	922005117
Nylon sling for double leg amputees	Size "M"	922005217
Nylon sling for double leg amputees	Size "L"	922005317
Nylon sling for double leg amputees	Size "XL"	922005417
Nylon sling for double leg amputees	Size "XXL"	922005517

<b>Slings with clips US/ Canada</b>		
<b>Slings with clips</b>	<b>Description</b>	<b>Art. N°</b>
Nylon transfer sling	Size S	922005103
Nylon transfer sling	Size M	922005203
Nylon transfer sling	Size L	922005303
Nylon transfer sling	Size XL	922005403
Nylon transfer sling	Size XXL	922005503
<b>Slings with clips + 10 cm (extended leg loops)</b>	<b>Description</b>	<b>Art. N°</b>
Nylon transfer sling	Size S	922005113
Nylon transfer sling	Size M	922005213
Nylon transfer sling	Size L	922005313
Nylon transfer sling	Size XL	922005413
Nylon transfer sling	Size XXL	922005513
<b>Slings with clips</b>	<b>Description</b>	<b>Art. N°</b>
Bathing sling	Size S	922006103
Bathing sling	Size M	922006203
Bathing sling	Size L	922006303
Bathing sling	Size XL	922006403
Bathing sling	Size XXL	922006503
<b>Slings with clips + 10 cm (extended leg loops)</b>	<b>Description</b>	<b>Art. N°</b>
Bathing sling	Size S	922006113
Bathing sling	Size M	922006213
Bathing sling	Size L	922006313
Bathing sling	Size XL	922006413
Bathing sling	Size XXL	922006513
<b>Slings with clips</b>	<b>Description</b>	<b>Art. N°</b>
Nylon toilet sling	Size S	922007103
Nylon toilet sling	Size M	922007203
Nylon toilet sling	Size L	922007303
Nylon toilet sling	Size XL	922007403
<b>Slings with clips + 10 cm (extended leg loops)</b>	<b>Description</b>	<b>Art. N°</b>
Nylon toilet sling	Size S	922007113
Nylon toilet sling	Size M	922007213
Nylon toilet sling	Size L	922007313
Nylon toilet sling	Size XL	922007413
<b>Slings with clips</b>	<b>Description</b>	<b>Art. N°</b>
Nylon sling for double leg amputees	Size S	922005117
Nylon sling for double leg amputees	Size M	922005217
Nylon sling for double leg amputees	Size L	922005317
Nylon sling for double leg amputees	Size XL	922005417
Nylon sling for double leg amputees	Size XXL	922005517

Transfer sling with clips	Description	Guidelines for sling sizes		
	made of nylon washable at max. 60°C	<b>Size</b> S M L XL XXL	<b>Weight</b> 35-65 kg 55-85 kg 75-125 kg 120-160 kg 160-210 kg	<b>Color</b> red yellow green blue orange
Bathing sling with clips	Description	Guideline for sling sizes		
	made of nylon washable at max. 60°C	<b>Size</b> S M L XL XXL	<b>Weight</b> 35-65 kg 55-85 kg 75-125 kg 120-160 kg 160-210 kg	<b>Color</b> red yellow green blue orange
Toilet sling with clips	Description	Guideline for sling sizes		
	made of nylon washable at max. 60°C	<b>Size</b> S M L XL XXL	<b>Weight</b> 35-65 kg 55-85 kg 75-125 kg 120-160 kg 160-210 kg	<b>Color</b> red yellow green blue orange
Sling with clips for double leg amputees	Description	Guideline for sling sizes		
	made of nylon with head support and safety clip system, washable at 60 ° C, suitable for 4-point suspension	<b>Size</b> S M L XL XXL	<b>Weight</b> 35-65 kg 55-85 kg 75-125 kg 120-160 kg 160-210 kg	<b>Color</b> red yellow green blue orange

## 13.6 Spare parts / Consumables

Spare parts and consumables are available upon request from your BEKA Hospitec distributor or directly from the manufacturer.

Please note:

You cannot change all parts yourself.

The installation may require the expertise of a trained specialist in electrical / plumbing.

## 13.7 Mounting instructions

### 13.7.1 Rear Castor Replacement

**Image 1:**

Required tools:

1 x 10 mm Allen wrench



**Image 2:**

Additional parts/tools:

1 x rear castor  
(Order number S9200130)  
1 x thread lock fluid  
(medium tight)



**Image 3:**

Put an object (e.g. wooden block) under the side where you want to replace the castor to free the castor.



**Image 4:**

Unscrew the screw of the castor using the Allen wrench.



**Image 5:**

Remove the screw of the castor. Hold the castor back with your hand! Remove the castor with the screw



**Image 6:**

Remove the cover plate with thread and fixing pins. Caution, the fixing pins are loose. Make sure you do not lose a fixing pin!



**Image 7:**

Prior to screwing a new castor, you must apply thread lock fluid (**medium tight at least 21 Nm**) to the thread of the screw.



**Caution: the thread lock fluid must dry at least 3 hours before the device can be loaded.**

**Should you use thread lock fluid from another manufacturer, the drying times specified by this manufacturer must be observed!**

**Re-assemble in reversed order!**

### 13.7.2 Front Castor Replacement

**Image 1:**  
Required tools:

1 x 10 mm Allen wrench

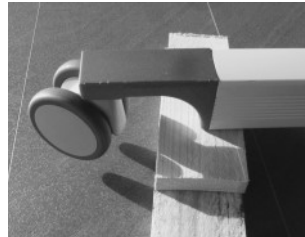

**Image 2:**  
Additional parts/tools:

1 x front castor  
(Order number  
S9200350)  
1 x thread lock fluid  
(medium tight)



**Image 3:**  
Put an object (e.g. wooden block) under the side where you want to replace the castor to free the castor.



**Image 4:**  
Unscrew the screw of the castor using the Allen wrench.



**Image 5:**  
Remove the screw of the castor. Hold the castor back with your hand!  
Remove the castor with the screw



**Image 6:**  
Prior to screwing a new castor, you must apply thread lock fluid (medium tight at least 21 Nm) to the thread of the screw.



**Caution: the thread lock fluid must dry at least 3 hours before the device can be loaded.**

**Should you use thread lock fluid from another manufacturer, the drying times specified by this manufacturer must be observed!**

**Re-assemble in reversed order!**

### 13.7.3 Control including Handle, Mounting Plate and Battery Compartment

**Image 1:**

Required tools:  
1 x 4 mm T-handle  
1 x 4 mm Allen wrench



**Image 2**

Tool for the battery mounting plate:  
1 x 2.5mm T-handle  
1 x 4mm T-handle



**Image 3:**

Remove the battery from the battery compartment



**Image 4:**

Unscrew and remove the left-hand screw of the handle in the mounting plate.



**Image 5:**

Unscrew and remove the right-hand screw of the handle in the mounting plate.



**Image 6:**

The image shows the mounting plate with the right-hand screw removed from the handle.



**Image 7:**

The image shows the mounting plate with the left-hand screw removed from the handle.



**Image 8:**

Unscrew the front right-hand screw from the handle.



**Image 9:**

Remove the front right-hand screw from the handle.

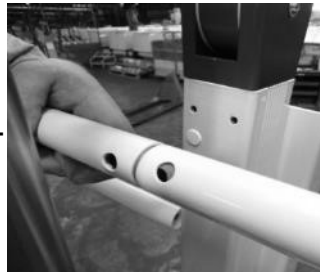

**Image 10:**

Unscrew the front left-hand screw from the handle.



**Image 11:**  
Remove the front left-hand screw from the handle.



**Image 12:**  
Remove the diode plug of the handset from the control box.



**Image 13:**  
Remove the jack plug of the lifting motor from the control box.



**Image 14:**  
Remove the jack plug of the spreading motor from the control box.



**Image 15:**  
Unscrew and remove the locking screw of the control box and remove the control box.



**Image 16:**  
Unscrew and remove the top locking screw from the battery compartment.



**Image 17:**  
Unscrew and remove the middle locking screw from the battery compartment.



**Image 18:**  
Unscrew and remove the bottom locking screw from the battery compartment.



**Image 19:**  
Remove the battery compartment from the mounting plate.



**Image 20:**  
Unscrew and remove the two top locking screws from the mounting plate.



**Image 21:**  
Unscrew and remove the two bottom locking screws from the mounting plate.



**Image 22:**  
Remove the mounting plate.



Re-assemble in reversed order!

### 13.7.4 Replacing the Battery

**Image 1:**  
The image shows the  
inserted battery.



**Image 3:**  
You can lift the  
battery up to remove  
it.

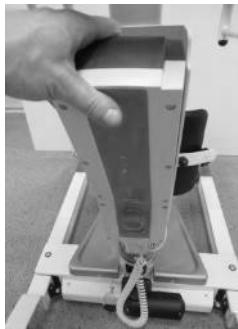

**Image 2:**  
Unlock the battery by  
means of the release  
lever in the battery  
handle.



**Image 4:**  
The image shows the  
removed battery.  
When replacing the  
battery, please check  
that the release lever  
engages audibly.





## 13.8 Electromagnetic Compatibility

Electrical medical equipment is subject to special precautionary measures with regard to EMC and must be installed and operated in accordance with the EMC instructions included in the accompanying documents.

For the devices and systems from BEKA Hospitec GmbH, no special measures must be observed.

Portable and mobile HF-communications equipment can interfere with electrical medical equipment.

<b>Guidance and manufacturer's declaration - electromagnetic immunity (Table 201)</b>		
The product been designed for use in the hereafter listed ELECTROMAGNETIC ENVIRONMENTS. The customer or the user of the product must ensure that the appliance is used in such environment.		
<b>Emission measurements</b>	<b>Compliance</b>	<b>Electromagnetic environment - guidelines</b>
High-frequency (HF) emissions to CISPR 11	Group 1	The product uses HF radiation exclusively for internal functions. Therefore, the HF radiation of the device is very low and any interference with adjacent electrical equipment is unlikely.
High-frequency (HF) emissions to CISPR 11	Class B	The product is intended for use in any type of facility including living quarters and those that are directly connected to a public mains network that supplies residential buildings and buildings used for domestic purposes.
Harmonics to IEC 61000-3-2	Class A	
Voltage fluctuations/ flicker to IEC 61000-3-3	Compliant	

<b>Guidance and manufacturer's declaration - electromagnetic immunity (Table 202)</b>			
The product been designed for use in the hereafter listed ELECTROMAGNETIC ENVIRONMENTS. The customer or the user of the product must ensure that the appliance is used in such environment.			
<b>Immunity testing</b>	<b>IEC 60601- Test level</b>	<b>Compliance level</b>	<b>Electromagnetic environment guidance</b>
Discharging of static electricity (ESD) to IEC 61000-4-2	± 6kV contact discharge ± 8kV air discharge	± 6kV contact discharge ± 8kV air discharge	The floor must be in wood, concrete or ceramic tiles. In case of floors in synthetic material, the relevant air humidity must be at least 30%.
Rapid transient interference pulses/burst IEC 61000-4-4	± 2 kV for power supply cables  ± 1 kV for input/output cables	± 2 kV for power supply cables  not applicable to input/output cables	The quality of the supply voltage should match that of a typical business or hospital environment.
Overvoltage IEC 61000-4-5	±1 kV cable against cable  ±2 kV cable against ground connection	±1 kV cable against cable  ±2 kV cable against ground connection	The quality of the supply voltage should match that of a typical business or hospital environment.
Voltage drops, short interruptions and voltage fluctuations in the power supply input cables IEC 61000-4-11	<5 % $U_T$ (>95 % drop of $U_T$ ) for 0.5 period  <40 % $U_T$ (>60 % drop of $U_T$ ) for 5 periods  <70 % $U_T$ (>30 % drop of $U_T$ ) for 25 periods  <5 % $U_T$ (>95 % drop of $U_T$ ) for 5 s	<5 % $U_T$ (>95 % drop of $U_T$ ) for 0.5 period  <40 % $U_T$ (>60 % drop of $U_T$ ) for 5 periods  <70 % $U_T$ (>30 % drop of $U_T$ ) for 25 periods  <5 % $U_T$ (>95 % drop of $U_T$ ) for 5s	The quality of the supply voltage should match that of a typical business or hospital environment.
Current frequency (50/60 Hz) Magnetic field IEC 61000-4-8	3 A/m	3 A/m	Power frequency magnetic fields should be at levels characteristic of a typical location in a typical business or hospital environment.
<b>CAUTION <math>U_T</math> is the mains AC voltage before the application of the test level.</b>			

Guidance and manufacturer's declaration - electromagnetic immunity (Table 204)			
The product been designed for use in the hereafter listed electromagnetic environments. The customer or the user of the product must ensure that the appliance is used in such environment.			
Immunity testing	IEC 60601-Test level	Compliance level	Electromagnetic environment guidance
Conducted HF IEC 61000-4-6	3 Vrms 150 kHz up to 80 MHz	10 Vrms	Portable and mobile HF communications equipment should be used no closer to any part of the product including cables, than the recommended separation distance calculated in accordance with the equation applicable to the frequency of the transmitter.
Radiation HF IEC 61000-4-3	3 V/m 80 MHz up to 2.5 GHz	3 V/m	<p><b>Recommended separation distance</b>  <math>d=0.35\sqrt{P}</math>  <math>d=1.2\sqrt{P}</math> 80 MHz up to 800 MHz  <math>d=2.3\sqrt{P}</math> 800 MHz up to 2.5 GHz</p> <p>With <math>P</math> as the rated output of the transmitter in Watt (W) in accordance with the manufacturer's specifications and <math>d</math> as the recommended separation distance in meter (m).</p> <p>The field strength of fixed HF-transmitters as determined by an electromagnetic field survey, <sup>a</sup> – should be less than the COMPLIANCE LEVEL in each frequency range. <sup>b</sup></p> <p>In the vicinity of equipment marked with the following symbol, interference may occur:</p> 
<p><b>NOTE 1:</b> At 80 MHz and 800 MHz, the higher frequency range applies.</p> <p><b>NOTE 2:</b> This manual could possibly not apply to all situations. Electromagnetic propagation is affected by absorption and reflection from structures, objects and people.</p> <p><sup>a</sup> The field strength of fixed RF transmitters, such as base stations of mobile phones and land mobile radios, amateur radio stations, AM and FM radios as well as radio and television broadcast media cannot be predicted theoretically with accuracy. To assess the electromagnetic environment due to fixed RF transmitters, an electromagnetic site survey is recommended. If the field strength measured in the environment where the product is to be used, exceeds the applicable HF compliance level, special care should be taken that a normal operation of the product can be guaranteed. In case anomalies are identified, additional measures could be required, such as a different alignment or a change of the location of the product.</p> <p><sup>b</sup> In the frequency range from 150 kHz to 80 MHz, the field strength must be less than 10 V/m.</p>			

**Recommended distance between portable and mobile communications equipment and the product (Table 206)**

The product is intended for use in an electromagnetic environment with controlled HF interferences. The customer or the user of the product can avoid electromagnetic interference by respecting and observing the minimum distance between portable and mobile HF telecommunication devices (transmitters) and the product depending on the rated output of the communication device as given below.

Rated output of the transmitter W	Separation distance depending on the transmitting frequency in m		
	150 kHz to 800 MHz $d=0.35\sqrt{P}$	80 MHz to 800 MHz $d=1.2\sqrt{P}$	800 MHz to 2.5 GHz $d=2.3\sqrt{P}$
0.01	0.04	0.12	0.23
0.1	0.11	0.38	0.73
1	0.35	1.2	2.3
10	1.1	3.8	7.3
100	3.5	12	23

For transmitters rated at a maximum output power not listed above, the recommended separation distance  $d$  in meters (m) can be determined using the equation applicable to the frequency of the transmitter, where  $P$  is the maximum output power rating of the transmitter in watts (W) according to the specifications given by the transmitter manufacturer.

**NOTE 1:** At 80 MHz and 800 MHz, the separation distance for the higher frequency range applies.

**NOTE 2:** These guidelines could not apply to all situations. Electromagnetic propagation is affected by absorption and reflection from structures, objects and people.

## 13.9 Journal

According the Medical Device Directive, you are compelled to keep a journal for this device. You can use this journal as template.

### *Journal*

Device: CARLO Alu

Manufacturer: BEKA Hospitec GmbH, Am Rübenmorgen 3, 35582 Wetzlar

Serial number: \_\_\_\_\_

Date of purchase: \_\_\_\_\_

Site: \_\_\_\_\_

Checks and inspection conducted upon the first use:

\_\_\_\_\_

Date: \_\_\_\_\_

### ***Evidence of the training session on the functions and the use of the product***

Instructor		Trained person	
Name	Date	Name	Signature

Periodic inspection, repair, DGUV-3, safety check, etc.

Type of inspection	Date	Result	Measure	Signature:

---

Your notes

.....  
.....  
.....  
.....  
.....  
.....  
.....  
.....  
.....  
.....  
.....  
.....  
.....  
.....  
.....  
.....  
.....  
.....  
.....  
.....  
.....  
.....  
.....  
.....  
.....

